

PCB layout of straight to PCB(S1 type)

■ R04-9PIS1

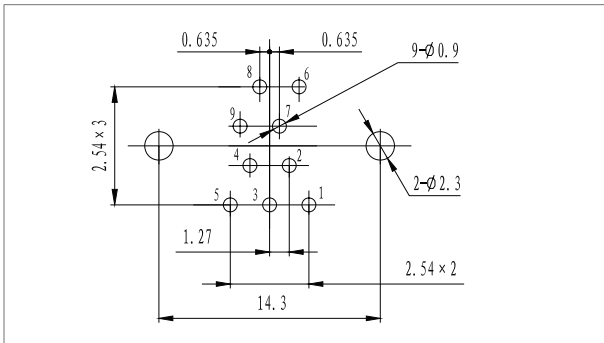

■ R04-9RHS1

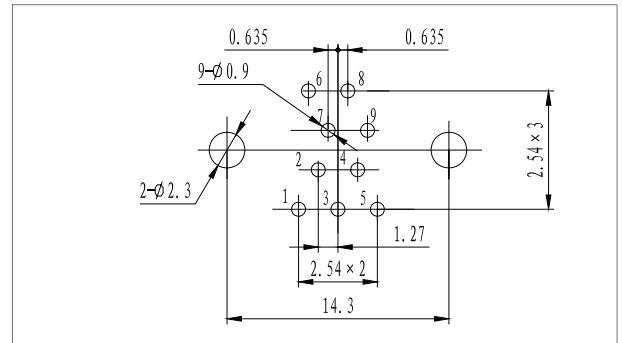

■ R04-15PIS1

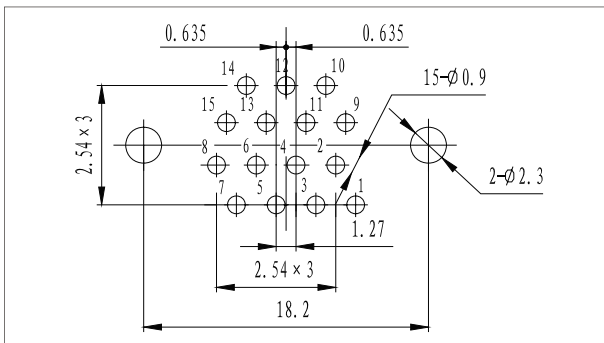

■ R04-15RHS1

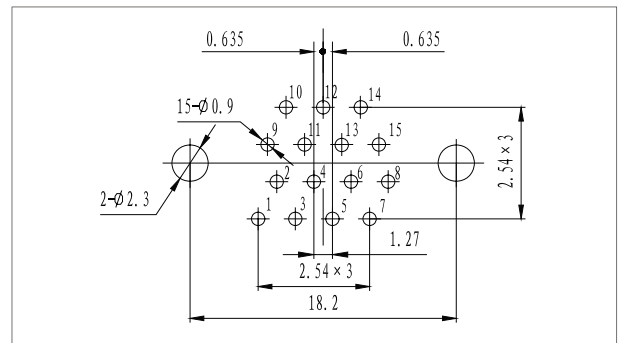

■ R04-21PIS1

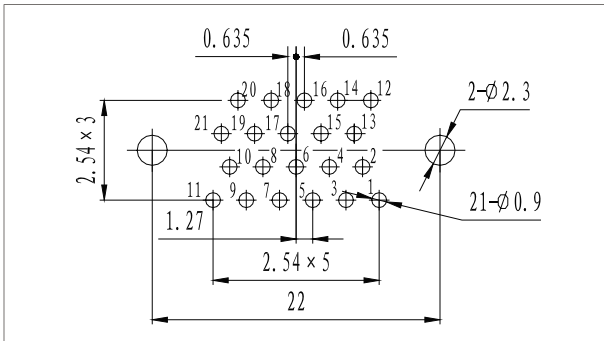

■ R04-21RHS1

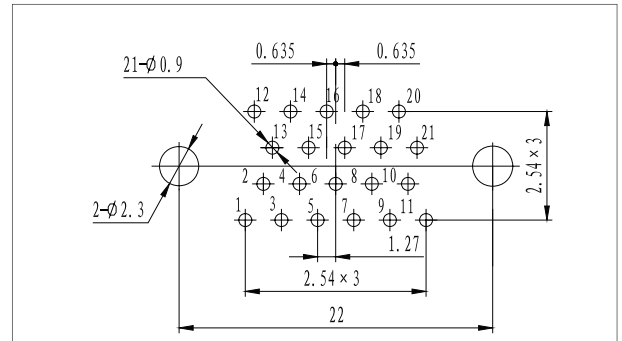

■ R04-25PIS1

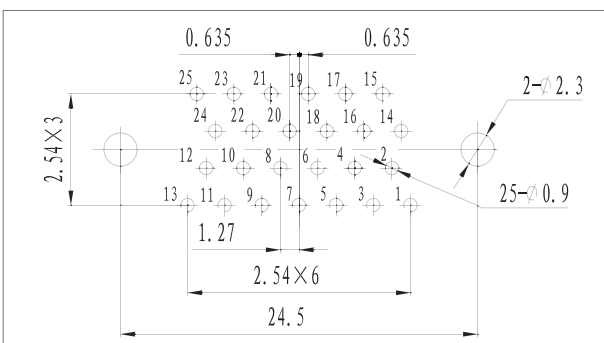

■ R04-25RHS1

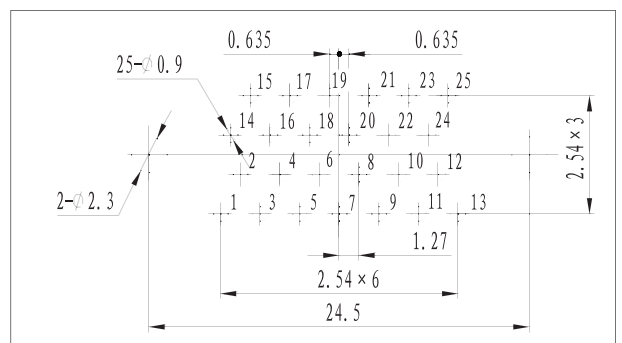

Note: All dimensions in mm

PCB layout of straight to PCB(S1 type)

■ R04-31PIS1

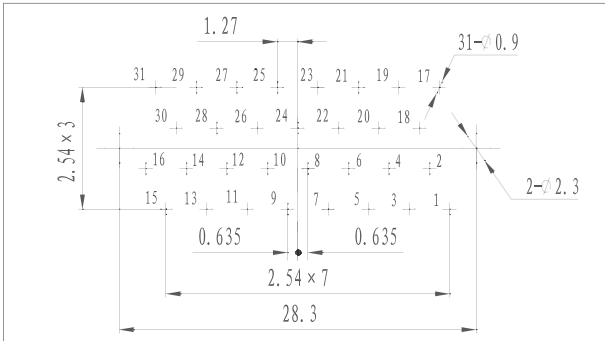

■ R04-31RHS1

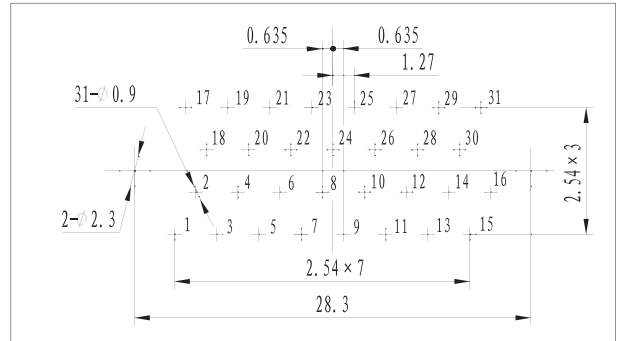

■ R04-37PIS1

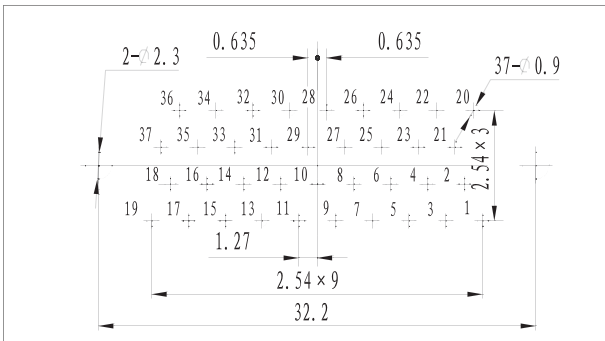

■ R04-37RHS1

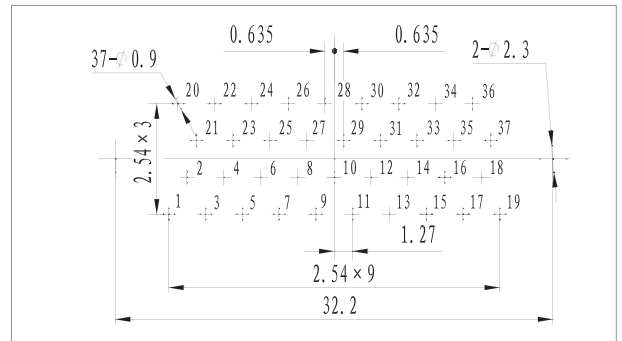

■ R04-51PIS1

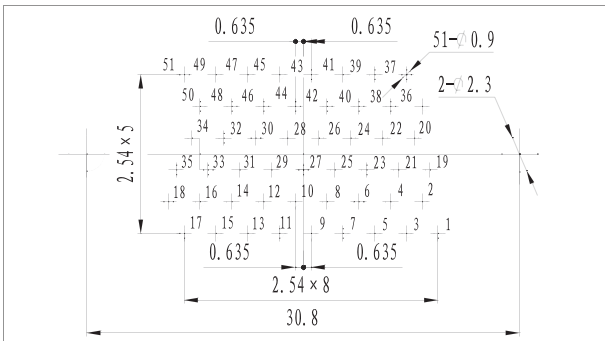

■ R04-51RHS1

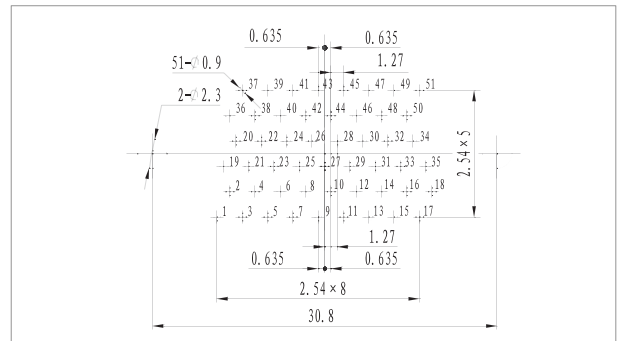

Note: All dimensions in mm