

SUNKYE



Sunkye is a company that specializes in producing specific connectors, which are widely used in both military and civil areas. The military areas include aerospace, aviation, electrical, ship-building, defense systems, and more, while the civil areas include communication, telecom, automotive, rail, oil & gas and others.

Company profile

The design team focuses on meeting customer requirements with continuous innovative technology, while the manufacturing team provides high-quality products by utilizing advanced equipment in standardized processes. This ensures that customers benefit from the products.

Sunkye is certified ISO-9001 and has passed UL, VDE, and CE certifications. Also ensures product quality by testing its products in realistic conditions with advanced test facilities and professional test employees.

The Sunkye team is committed to offering high-quality products, the best service, prompt delivery, and competitive prices for its customers.



Manufacture Equipment:

Five-Axis CNC, AGIE EDM, SODICK WEDM-LS, 40G Vector Network Analyzers, Vacuum Heat Treatment Equipment, Glass-sintered System, Laser Processing Center, High Velocity Ram Machine, Gold, Nickel and Cadmium Plating Production Line, Thermosetting Injection Machine, Thermoplastic Injection Machine, Swiss Automatic Lathe, etc.

Test Facilities:

Comprehensive Test Instrument of Temperature, Humidity and Vibration; Experimental Box of Temperature and Shock; Layer Thickness Meter; Coordinate Measurement Machine, etc.





MIL-DTL-38999 III Series Connectors

SUNKYE

CONTENT

MIL-DTL-38999 III Series Connectors

Brief Introduction.....	6-7
How to Order	8-19
Backshells	20-22
Protective Cover.....	23-24
Contact Arrangement.....	25-45
Contact Diagram.....	46-48

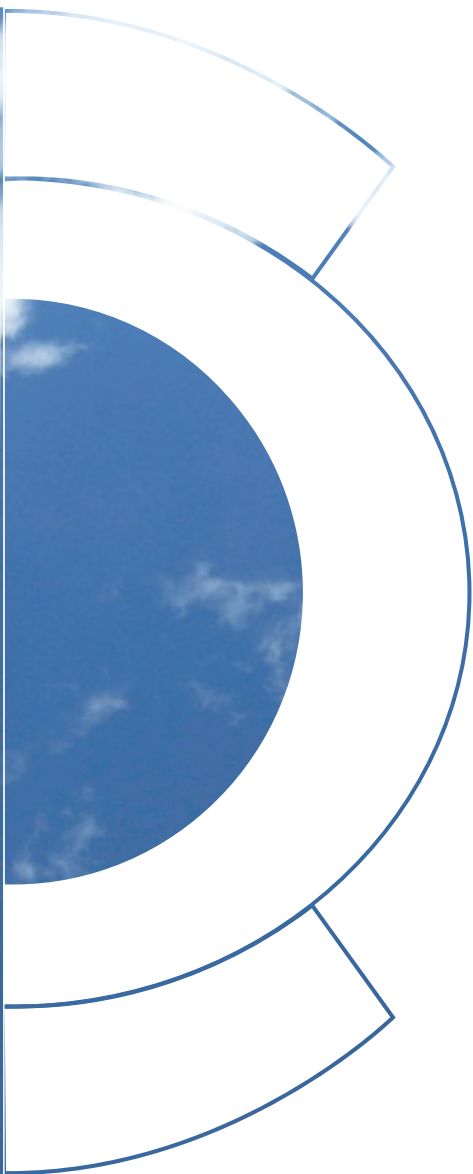



MIL-DTL-38999 III Series Connector

Brief Introduction

- Quick lock thread with anti-loosening mechanism
- 100% Scoop-proof to ensure no damage to the contacts in a blind mating application
- With grounding needs to strengthen emi/rfi shielding
- Excellent performance of shock & vibration resistance
- Good performance of fluid resistance
- Widely used in aerospace, aviation & military system, especially for high impact vibration environment



MIL-DTL-38999 III Master Keyway/ Keying Positions

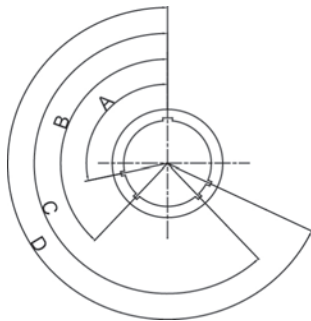

Receptacle Mate View

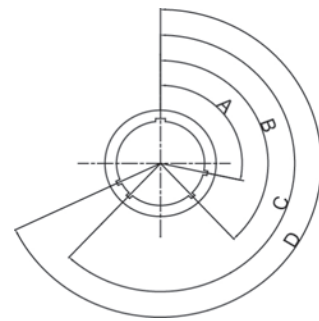

Plug Mate View

Shell No.	Shell No. Code	Keying Angle	N	A	B	C	D	E
09	A	A0	105	102	80	35	64	91
		B0	140	132	118	140	155	131
		C0	215	248	230	205	234	197
		D0	265	320	312	275	304	240
11,13,15	B,C,D	A0	95	113	90	53	119	51
		B0	141	156	145	156	146	141
		C0	208	182	195	220	176	184
		D0	236	293	252	255	298	242
17,19,21, 23,25	E,F,G, H,J	A0	80	135	49	66	62	79
		B0	142	170	169	140	145	153
		C0	196	200	200	200	180	197
		D0	293	310	244	257	280	272



Straight to PCB Termination and Size

38999/24 Type Receptacle

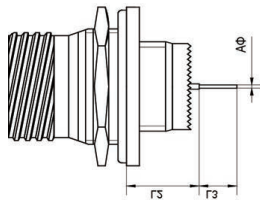

38999/20 Type Receptacle

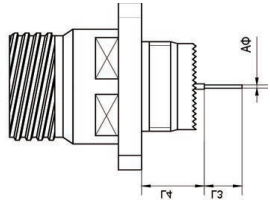

Straight to PCB Termination Contact Specification		L3	A
#22D	long straight to PCB termination contact PL SL	8.50	0.70
	short straight to PCB termination contact PC SC	4.00	
#20	long straight to PCB termination contact PL SL	8.50	0.70
	short straight to PCB termination contact PC SC	5.10	
#16	long straight to PCB termination contact PL SL	8.50	1.15
	short straight to PCB termination contact PC SC	5.10	

Length for Different Size Contact			Shell No. 09,11	Shell No. 13,15,17,19	Shell No. 21,23,25
	inserted contact				
L2	#22D pin	min.	10.52	10.34	
		max.	11.46	11.28	
	#22D socket	min.	10.19	10.01	
		max.	11.46	11.28	
	#20 or #16 pin,socket	min.	10.69	10.51	
		max.	11.63	11.45	
L4	#22D pin	min.	9.48		9.59
		max.	10.58		10.69
	#22D socket	min.	9.15		9.26
		max.	10.58		10.69
	#20 or #16 pin,socket	min.	9.65		9.76
		max.	10.75		10.86

Solder Contact Termination Size

26 Type Plug

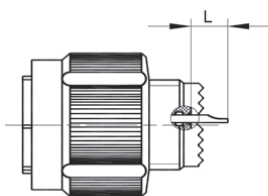

24 Type Receptacle

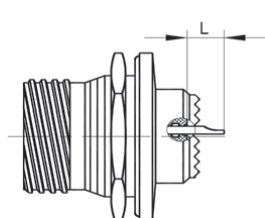

20 Type Receptacle

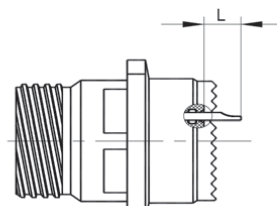

Note : L means the distance between the contact solder cup and the sealing wire



MIL-DTL-38999 III Series Small Circular Connector With Environment High Density Resistance

Material

- Shell : aluminum alloy, stainless steel, titanium alloy
- Finish : olive drab cadmium (W), chemical nickel plating (F)
stainless steel passivation (K), stainless steel nickel plating (S)
titanium alloy electroless (TT)
- Insulation Mounting Plate : thermoplast
- Seal Ring : silicon rubber elastomer
- Contact : copper alloy
- Finish : nickel plated with gold

Mechanical Performance

- Sinusoidal Vibration : 10–50Hz, speed 254mm/s
50–140Hz, double –amplitude 1.5mm
140–2000Hz, acceleration 588m/s²
- Random Vibration : high temperature 96(m/s²)²/ Hz 408 m/s², 100 ~ 1000Hz
- Random Vibration : environment temperature 480(m/s²)²/ Hz, 100 ~ 300Hz
- Shock : 2940m/s² 3ms
- Durability : 500 mating cycles
- Contact Retentivity (Min.) :
#22D : 44N
#20 : 67N
#16 : 111N
#12 : 111N
#8 coaxial : 111N
#8 triax : 111N

Electrical Performance

- Dielectric Strength (Vr.m.s) (Inserted Condition)

Rated Condition	M	N	I	II
seal level	1300	1000	1800	2300
21000m	800	600	1000	1000

- Contact Resistance (to lead silver conductor) & Rated Current

Contact No.	Insertion Diameter	Contact Resistance mΩ	Rated Current A
#22D	φ 0.762	14.6	5
#20	φ 1.02	7.3	7.5
#16	φ 1.588	3.8	13
#12	φ 2.39	1.8	23
#10	φ 3.18	1.0	33
#8	φ 3.61	0.6	46
#6	φ 4.52	0.5	60
#4	φ 5.72	0.3	80



Electrical Performance

- Insulation Resistance : $\geq 5000M\Omega$ (500V DC)
- Electrical Conductivity Between the Shells
 Olive drab cadmium plating (w) : 2.5Mv chemical nickel plating : 1mv
 Stainless steel passivation (k) : 10mv stainless steel with nickel plating (s) : 1mv
 Titanium alloy electroless (TT) : 10mV
- Shielding :
 100MHz : 90dB(F,W,S) 80dB(K,TT)
 1GHz : 85dB(F,W,S) 65dB(K,TT)
 10GHz : 65dB(F,S) 50dB(W) 45dB(K,TT)
- Coaxial Contact :
 Frequency : 0–1GHz characteristic impedance : 50 Ω
 VSWR ≤ 1.3
- Triax Contact :
 Bandwidth : 0–20MHz
 Rated voltage : 500V AC (max.)
 125V AC in 21000m
 Voltage drop : inner & middle contact : ≤ 55 mmV in 1A
 Outer contact : ≤ 75 mmV in 12A

Environment Performance

- Temperature Range : olive drab cadmium plating (W) : $-65^{\circ}\text{C} \sim +175^{\circ}\text{C}$
 chemical nickel plating (F, K, S, TT) : $-65^{\circ}\text{C} \sim +200^{\circ}\text{C}$
- Salt Spray : 500h (W, K) 48h (F, S) 1000h (TT)
- Humidity Resistance : 24h each cycle, 10 cycles
- Fluid Resistance : hydraulic oil, refrigerating fluid, and other 12 solvents

Name :

D38999/ 20 W B 35 P N -U
 ① ② ③ ④ ⑤ ⑥ ⑦ ⑧

- ① Serial No. : D38999
- ② Shell Type : 20 – wall square flange receptacle
 24 – jam nut mount receptacle
 26 – straight plug
- ③ Finish : W – olive drab cadmium plating, $-65^{\circ}\text{C} \sim +175^{\circ}\text{C}$
 F – chemical nickel plating, $-65^{\circ}\text{C} \sim +200^{\circ}\text{C}$
 K – stainless steel passivation, $-65^{\circ}\text{C} \sim +200^{\circ}\text{C}$
 S – stainless steel nickel plating, $-65^{\circ}\text{C} \sim +200^{\circ}\text{C}$
 TT – titanium alloy electroless, $-65^{\circ}\text{C} \sim +200^{\circ}\text{C}$
- ④ Shell No. : 09 11 13 15 17 19 21 23 25
 Shell No. Code : A B C D E F G H J
- ⑤ Contact Arrangement
- ⑥ Contact Style : P – standard crimping pin S – standard crimping socket
 A – no pin or customized pin B – no socket or customized socket
 PH – solder cup pin SH – solder cup socket
 PC – short type straight to PCB termination pin SC – short type straight to PCB termination socket
 PL – long straight to PCB termination pin SL – long type straight to PCB termination socket



⑦ Master Keyway/Keying Position : N-normal A, B, C, D

⑧ Marking Instruction : U--left plug, No mark--right plug

Note 1. See PCB hole size for the PCB hole

Note 2. If order the terminal accessory with products together, please write "product model + terminal accessory model" in the purchase order, also the terminal accessory can be ordered separately.

Note 3. #8 default to solder contact when the contact type is PH or SH. If change #8 solder contact to #8 coaxial contact, just put "/G" behind the model. Also changing to #8 triax contact, put /G1 behind the model.

Note 4. Wall sealing receptacle can only use pin contact, while the plug should adopt socket contact for the mating usage with receptacle.

Each wall sealing receptacle should use two plugs, left and right plug, left plug with a U mark and right plug without mark.

D38999/26 Plug Outline Dimensions

D 3 8 9 9 9 / 2 6 W

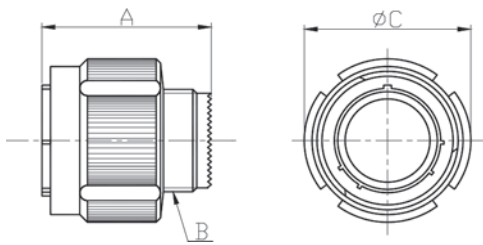

Shell No.	Shell No. Code	A max		Thread B	C max
09	A	31.00	A	M12 × 1-6g	21.80
11	B	31.00	B	M15 × 1-6g	25.00
13	C	31.00	C	M18 × 1-6g	29.40
15	D	31.00	D	M22 × 1-6g	32.50
17	E	31.00	E	M25 × 1-6g	35.70
19	F	31.00	F	M28 × 1-6g	38.50
21	G	31.00	G	M31 × 1-6g	41.70
23	H	31.00	H	M34 × 1-6g	44.90
25	J	31.00	J	M37 × 1-6g	48.00

D38999/20 Square Flange Receptacle

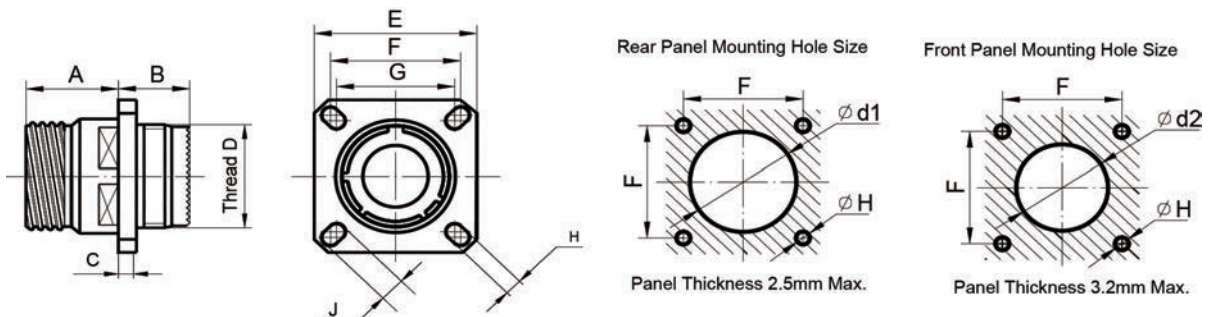



D 3 8 9 9 9 / 2 0 W

Shell No.	Shell No. Code	A max	B max	C max	Thread D	E		F	G	H	J	d1	d2
09	A	20.80	10.90	2.50	M12 × 1-6g	23.80	A	18.26	15.09	3.25	5.49	16.66	13.11
11	B	20.80	10.90	2.50	M15 × 1-6g	26.20	B	20.62	18.26	3.25	4.93	20.22	15.88
13	C	20.80	10.90	2.50	M18 × 1-6g	28.60	C	23.01	20.62	3.25	4.93	23.42	19.05
15	D	20.80	10.90	2.50	M22 × 1-6g	31.00	D	24.61	23.01	3.25	4.39	26.59	23.01
17	E	20.80	10.90	2.50	M25 × 1-6g	33.30	E	26.97	24.61	3.25	4.93	30.96	25.81
19	F	20.80	10.90	2.50	M28 × 1-6g	36.50	F	29.36	26.97	3.25	4.93	32.94	28.98
21	G	20.10	11.60	3.20	M31 × 1-6g	39.70	G	31.75	29.36	3.25	4.93	36.12	32.16
23	H	20.10	11.60	3.20	M34 × 1-6g	42.90	H	34.93	31.75	3.91	6.15	39.29	34.93
25	J	20.10	11.60	3.20	M37 × 1-6g	46.00	J	38.10	34.93	3.91	6.15	42.47	37.69

D38999/24 Jam Nut Mounting Receptacle

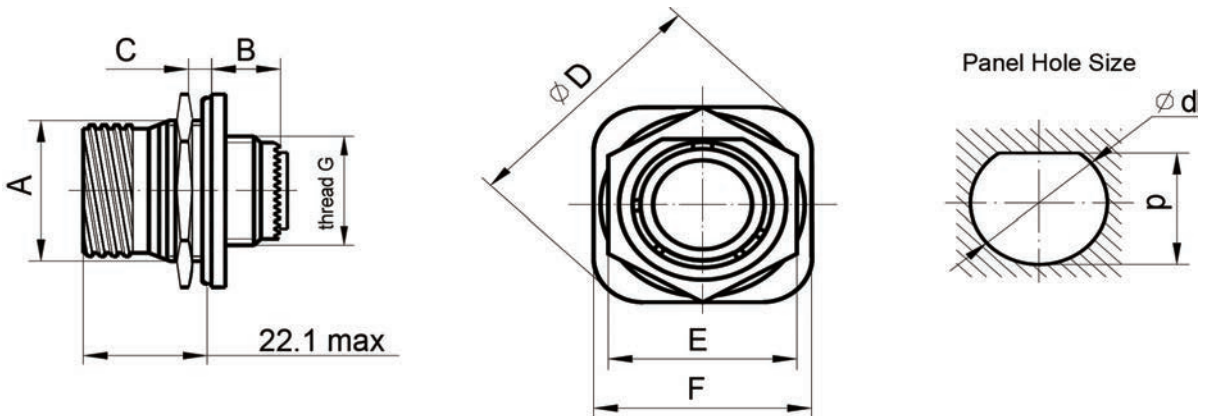

D 3 8 9 9 9 / 2 4 W

Shell No.	Shell No. Code	A	B max	C max	D max		E max	F	Thread G	d	p
09	A	16.53	10.1	3.20	30.50	A	24.00	27.00	M12 × 1-6g	17.78	17.02
11	B	19.07	10.1	3.20	35.20	B	27.00	31.80	M15 × 1-6g	20.96	19.59
13	C	23.82	10.1	3.20	38.40	C	32.00	34.90	M18 × 1-6g	25.65	24.26
15	D	26.97	10.1	3.20	41.60	D	36.00	38.10	M22 × 1-6g	28.83	27.56
17	E	30.15	10.1	3.20	44.80	E	37.00	41.30	M25 × 1-6g	32.01	30.73
19	F	33.32	10.6	3.20	49.50	F	41.00	46.00	M28 × 1-6g	35.18	33.91
21	G	36.50	10.6	3.20	52.70	G	46.00	49.20	M31 × 1-6g	38.35	37.08
23	H	39.67	10.6	3.20	55.90	H	50.00	52.40	M34 × 1-6g	41.53	40.26
25	I	42.85	10.6	3.20	59.00	J	51.23	55.60	M37 × 1-6g	44.70	43.43



MIL-DTL-38999 III Series Small Circular Sealing Connector With Environment High Density Resistance

Material

- Shell : stainless steel
- Finish : stainless steel passivation (E)
 stainless steel with nickel plating (N)
- Sealed Insulation Medium : glass

Environment Performance

- Temperature Range : stainless steel passivation (E) : -65°C ~ +200°C
 stainless steel with nickel plating (N) : -65°C ~ +200°C
- Salt Spray : 500h (E) 48h (N)
- Tightness : $1 \times 10^{-3} \text{Pa} \cdot \text{cm}^3/\text{s}$

Name :

D38999/ 21 Y B 35 P N
 ① ② ③ ④ ⑤ ⑥ ⑦

- ① Serial No. : D38999
- ② Shell Type : 21 – square flange mount gas sealing receptacle
 23 – jam nut mount gas sealing receptacle
 25 – solder mount gas sealing receptacle
 27 – tin solder mount sealing receptacle
- ③ Finish : Y – stainless steel passivation
 N – stainless steel with nickel plating
- ④ Shell No. : 09 11 13 15 17 19 21 23 25
Shell No. Code : A B C D E F G H J
- ⑤ Contact Arrangement
- ⑥ Contact Style : P – solder pin
 X – pin contact with connecting grommet (gas sealing type)
- ⑦ Master Keyway/ Keying Position : N-normal A, B, C, D, E



Outline Dimensions

D38999/21 Square Flange Receptacle

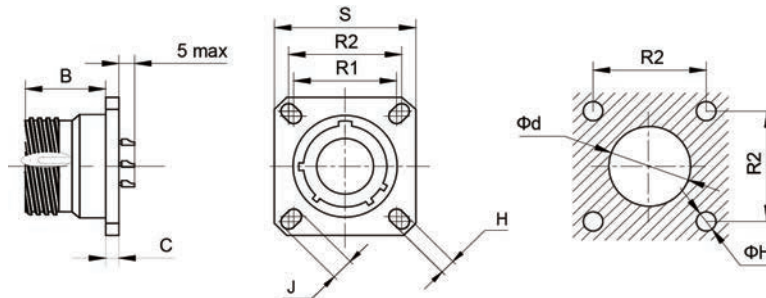

D 3 8 9 9 9 / 2 1 Y

Shell No.	B max	C	J	H		R1	R2	S	d ^{+0.2} ₀
09	21.4	2.50	5.49	3.25	A	15.09	18.26	23.8	8.0
11	21.4	2.50	4.93	3.25	B	18.26	20.62	26.2	11.3
13	21.4	2.50	4.93	3.25	C	20.62	23.01	28.6	14.2
15	21.4	2.50	4.39	3.25	D	23.01	24.61	31.0	17.3
17	21.4	2.50	4.93	3.25	E	24.61	26.97	33.3	20.5
19	21.4	2.50	4.93	3.25	F	26.97	29.36	36.5	22.8
21	21.4	2.50	4.93	3.25	G	29.36	31.75	39.7	25.9
23	21.4	2.50	6.15	3.91	H	31.75	34.93	42.9	29.1
25	21.4	2.50	6.15	3.91	J	34.93	38.10	46.0	32.3

D38999/23 Jam Nut Mount Receptacle

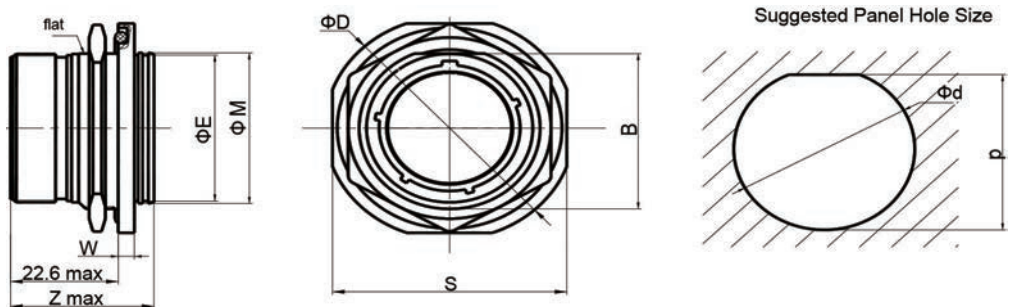

D 3 8 9 9 9 / 2 1 Y

Shell No.	Z max	D	S	W	B		E	M	P	d
09	29.2	30.2	27.0	2.6	16.6	A	15.3	16.4	17.02	17.78
11	29.2	34.9	31.8	2.6	19.1	B	18.4	19.5	19.59	20.96
13	29.2	38.1	34.9	2.6	23.9	C	21.6	22.8	24.26	25.65
15	29.2	41.3	38.1	2.6	27.0	D	24.8	26.0	27.56	28.83
17	29.2	44.5	41.3	2.6	30.2	E	28.0	29.1	30.73	32.01
19	30.1	49.2	46.0	3.4	33.3	F	31.2	32.3	33.91	35.18
21	30.1	52.4	46.0	3.4	36.55	G	34.3	35.5	37.08	38.35
23	30.1	55.6	52.4	3.4	39.7	H	37.5	39.7	40.26	41.53
25	30.1	58.7	55.6	3.4	42.9	J	40.7	42.9	43.43	44.70



D38999/25 Solder Mount Gas Sealing Receptacle

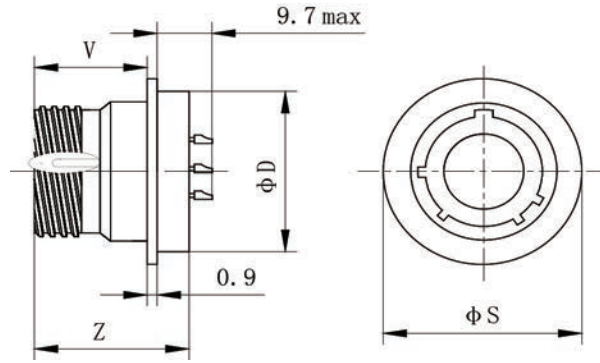

D 3 8 9 9 9 / 2 5 Y

Shell No.	Z max	V max		S	D
09	23.8	17.2	A	19.4	17.1
11	23.8	17.2	B	21.8	19.9
13	23.8	17.2	C	24.9	23.1
15	23.8	17.2	D	28.1	26.2
17	23.8	17.2	E	31.3	29.4
19	23.8	17.2	F	33.6	31.8
21	23.8	17.2	G	36.8	35.0
23	24.6	17.2	H	40.0	38.2
25	24.6	17.2	J	43.2	41.3

D38999/27 Fusion Solder Mount Sealing Receptacle

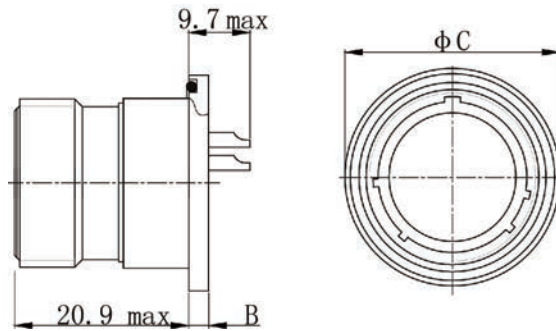

D 3 8 9 9 9 / 2 7 Y

Shell No.	Shell No. Code		phi C max	B ± 0.2
09	A	A	25.0	3.2
11	B	B	28.1	3.2
13	C	C	31.3	3.2
15	D	D	34.5	3.2
17	E	E	36.7	3.2
19	F	F	40.4	3.2
21	G	G	44.0	3.2
23	H	H	48.2	4.0
25	J	J	50.4	4.0



MIL-DTL-38999 III Series Small Circular Wall Mount Connector With Environment High Density Resistance

Material

- Shell : stainless steel
Finish : stainless steel passivation (Y)
 stainless steel with nickel plating (N)
- Sealed Insulating Medium : glass

Temperature Performance

- Temperature Range : stainless steel passivation (Y) : -65°C ~ +200°C
 stainless steel with nickel plating (N) : -65°C ~ +200°C
- Salt Spray : 500h (Y) 48h (N)
- Tightness : $1 \times 10^{-3} \text{Pa} \cdot \text{cm}^3/\text{s}$

Name :

D38999/ 20 Y B 35 C N
 ① ② ③ ④ ⑤ ⑥ ⑦

- ① Serial No. : D38999
- ② Shell Type : 20 – wall square flange wall mount receptacle
 24 – wall square flange receptacle
- ③ Finish : Y – gas sealing, stainless steel outer shell passivation, -65°C ~ +200°C
 N – gas sealing, stainless steel outer shell with nickel plating, -65°C ~ +200°C
- ④ Shell No. : 09 11 13 15 17 19 21 23 25
Shell No. Code : A B C D E F G H J
- ⑤ Contact Arrangement
- ⑥ Contact Style : C – wall mount pin
- ⑦ Master Keyway/ Keying Position : N-normal A, B, C, D, E

Outline Dimensions

D38999/20 Wall Square Flange Wall Mount Receptacle

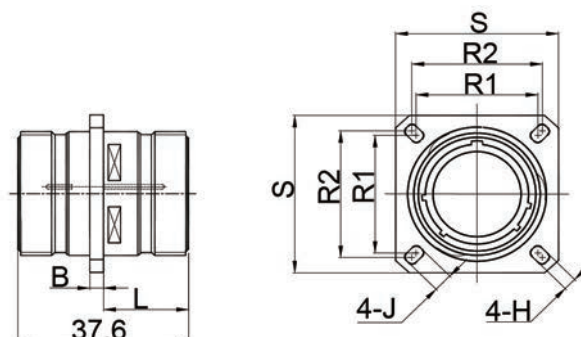



D 3 8 9 9 9 / 2 0 Y

Shell No.	Shell No. Code	L	B	S		R1	R2	H	J
09	A	19.5	3.2	23.8	A	15.09	18.26	3.25	5.49
11	B	19.5	3.2	26.2	B	18.26	20.62	3.25	4.93
13	C	19.5	3.2	28.6	C	20.62	23.01	3.25	4.93
15	D	19.5	3.2	31.0	D	23.01	24.61	3.25	4.93
17	E	19.5	3.2	33.3	E	24.61	26.97	3.25	4.93
19	F	19.5	3.2	36.5	F	26.97	29.36	3.25	4.93
21	G	18.7	3.2	39.7	G	29.36	31.75	3.25	4.93
23	H	18.7	3.2	42.9	H	31.75	34.93	3.91	6.15
25	J	18.7	3.2	46.0	J	34.93	38.10	3.91	6.15

D38999/24 Jam Nut Wall Mount Sealing Receptacle

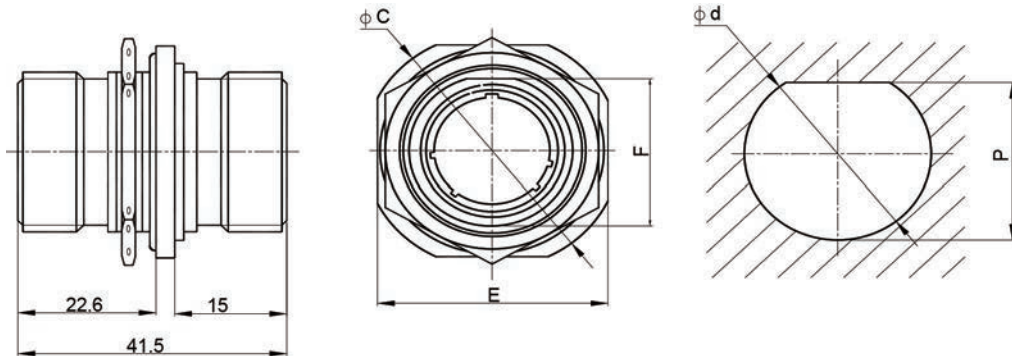

D 3 8 9 9 9 / 2 0 Y

Shell No.	Shell No. Code	ϕC	E		F	$\phi d^{+0.2}_0$	p
09	A	30.5	27.0	A	16.53	17.78	17.02
11	B	35.2	31.8	B	19.07	20.96	19.59
13	C	38.4	34.9	C	23.82	25.65	24.26
15	D	41.6	38.1	D	26.97	28.83	27.56
17	E	44.8	41.3	E	30.15	32.01	30.73
19	F	49.5	46.0	F	33.32	35.18	33.91
21	G	52.7	49.2	G	36.50	38.35	37.08
23	H	55.9	52.4	H	39.67	41.53	40.26
25	J	59.0	55.6	J	42.85	44.70	43.43



MIL-DTL-38999 III Series Small Circular Span Wire Separating Connector With Environment High Density Resistance

Material

- Shell : aluminum alloy
Finish : olive drab cadmium plating (W)
- Span Wire : multistrand of stainless steel wire rope

Mechanical Performance

- Durability : 500 times
- Vibration : 10Hz ~ 2000Hz , 1.0g²m/Hz
- External Bending Moment : 28.3 N · m
- Shock : 300g
- Span Wire Tolerance : 900N
- Separating Force : normal axis direction 160 ~ 400N
- 15 degree angle to normal axis direction 160 ~ 445N

Electrical Performance

- Voltage : 250V
- Dielectric Strength : 1000V

Environment Performance

- Environment Temperature : -65°C ~ +175°C
- Salt Spray : 500h
- Rainfall Test : rainfall speed $2^{+0.3}_{-0.2}$ mm/min
raindrop diameter 0.5mm-4.5mm
rainfall time 40 min
- Tightness : with water & rain proof while insertion

Name :

D38999/ 31 W E 20 P N 1
① ② ③ ④ ⑤ ⑥ ⑦ ⑧

- ① Serial No. : D38999
- ② Shell Type : #31-25 shell span wire separating plug
- ③ Class : W- olive drab cadmium plating, -65°C ~ +175°C
- ④ Span Wire Length Code : E F G H I J K L
Span Wire Length : 153 166 178 191 203 216 229 242
- ⑤ Contact Arrangement
- ⑥ Contact Style : P - standard crimping pin A - no pin or customized pin
- ⑦ Master Keyway/ Keying Position : N-normal A, B, C, D, E
- ⑧ Type Code : type 1, type 2, type 3, type 4, type 5, type 6

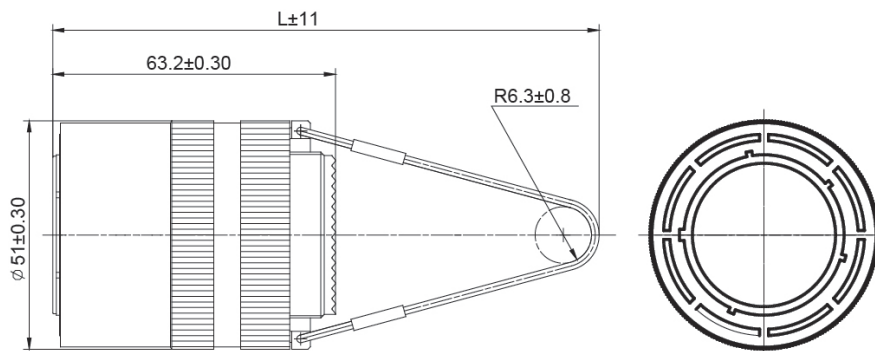



MIL-DTL-38999 III Series Small Circular Span Wire Separating Connector With Environment High Density Resistance

Brief Introduction

- Quick lock thread with anti-loosening mechanism
- 100% scoop-proof to ensure no damage to the contacts in a blind mating application
- With grounding needs to strengthen EMI/RFI shielding
- 25% lighter than the general aluminum shell type

Material

- Shell : carbon fiber reinforced thermoplastic material
Finish : olive drab cadmium plating (J) nickel plating (M)
- Insulation Mounting Plate : thermoplast
- Seal Ring : silicon rubber elastomer
- Contact : copper alloy
- Finish : nickel with gold plating

Mechanical Performance

- Durability : 1500 mating cycles

Electrical Performance

- Electrical Conductivity Between the Shell : 3mV
- Shielding : 100MHz : 90dB 1GHz : 85dB
10GHz(M) : 65dB 10GHz(J) : 50dB

Environment Performance

- Temperature Range : olive drab cadmium plating (J) : -65°C ~ +175°C
nickel plating (M) : -65°C ~ +200°C
- Salt Spray : 2000h

Name :

D38999/ 20 J B 35 H N
 ① ② ③ ④ ⑤ ⑥ ⑦

- ① Serial No. : D38999
- ② Shell Type : 20 – wall square flange wall mount receptacle
26 – straight shielding plug
- ③ Finish : J – composite with olive drab cadmium plating (electric conduction)
M – composite with chemical nickel plating (electric conduction)
- ④ Shell No. : 09 11 13 15 17 19 21 23 25
Shell No. Code : A B C D E F G H J
- ⑤ Contact Arrangement
- ⑥ Contact Style : P-pin (1500 mating cycles)
S-socket (1500 mating cycles)
A – no pin or customized pin
B – no socket or customized socket
- ⑦ Master Keyway/ Keying Position : N-normal A, B, C, D, E



D38999/20 Square Flange Receptacle

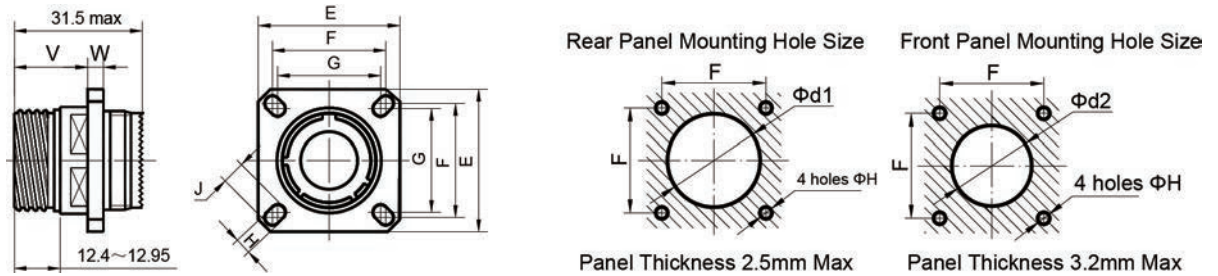

D 3 8 9 9 9 / 2 0 J

Shell No.	Shell No. Code	E ± 0.3	F	G	H ± 0.2	J ± 0.2	V+1.4	W	d1	d2	
09	A	23.80	18.26	15.09	3.25	A	5.49	19.5	3.65 ~ 2.1	16.66	13.11
11	B	26.20	20.62	18.26	3.25	B	4.93	19.5	3.65 ~ 2.1	20.22	15.88
13	C	28.60	23.01	20.62	3.25	C	4.93	19.5	3.65 ~ 2.1	23.42	19.05
15	D	31.00	24.61	23.01	3.25	D	4.39	19.5	3.65 ~ 2.1	26.59	23.01
17	E	33.30	26.97	24.61	3.25	E	4.93	19.5	3.65 ~ 2.1	30.96	25.81
19	F	36.50	29.36	26.97	3.25	F	4.93	19.5	3.65 ~ 2.1	32.94	28.98
21	G	39.70	31.75	29.39	3.25	G	4.93	18.7	4.35 ~ 2.1	36.12	32.16
23	H	42.90	34.93	31.75	3.91	H	6.15	18.7	4.35 ~ 2.1	39.29	34.93
25	J	46.00	38.10	34.93	3.91	J	6.15	18.7	4.35 ~ 2.1	42.47	37.69

D38999/26 Plug

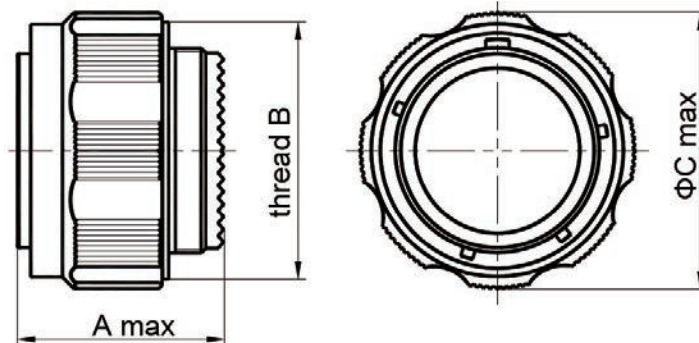

D 3 8 9 9 9 / 2 6 J

Shell No.	Shell No. Code	A	Thread B	C
09	A	31.00	M12 × 1-6g	21.80
11	B	31.00	M15 × 1-6g	25.00
13	C	31.00	M18 × 1-6g	29.40
15	D	31.00	M22 × 1-6g	32.50
17	E	31.00	M25 × 1-6g	35.70
19	F	31.00	M28 × 1-6g	38.50
21	G	31.00	M31 × 1-6g	41.70
23	H	31.00	M34 × 1-6g	44.90
25	J	31.00	M37 × 1-6g	48.00



Standard Terminal Accessory

M85049/ 14

$\frac{85049/}{\textcircled{1}}$ $\frac{14}{\textcircled{2}}$ $\frac{-}{\textcircled{3}}$ $\frac{11}{\textcircled{4}}$ $\frac{N}{\textcircled{5}}$

- ① Serial No. : 85049/
- ② Terminal Shell Accessory Type : 14–straight crimping sleeve
- ③ No Code — non self–locking
S — self–locking
- ④ Shell No. : 09 11 13 15 17 19 21 23 25
- ⑤ Coating : N–nickel plating (only for air force and aviation device)
W – olive drab cadmium plating
S –stainless steel passivation
TT–titanium alloy electroless

Stereogram



Outline Dimension

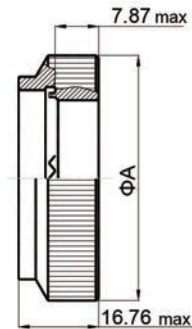

M 8 5 0 4 9 / 1 4 -

Shell No.	φ A max
09	21.8
11	25.0
13	29.29
15	32.49
17	35.71
19	38.50
21	41.71
23	44.91
25	47.98



M85049/ 38

M85049/ 38 - 11 N
① ② ③ ④ ⑤

- ① Serial No. : M85049/
- ② Terminal shell Accessory Type : 38-straight cable clamp
- ③ No Code — non self-locking
S — self-locking
- ④ Shell No. : 09 11 13 15 17 19 21 23 25
- ⑤ Finish : A – black anodization
N – nickel plating
W – olive drab cadmium plating
S – stainless steel passivation
TT – titanium alloy electroless

Stereogram



Outline Dimension

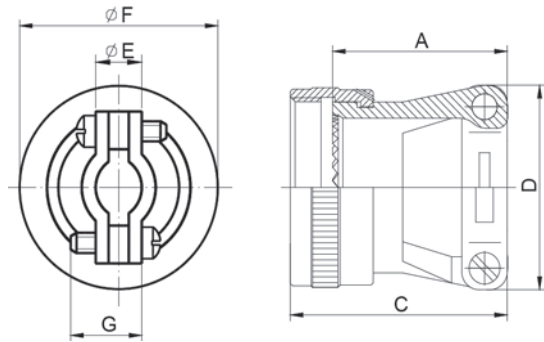

M 8 5 0 4 9 / 3 8 -

Shell No.	A max	C max	D max	F max	Adapted Cable Diameter		G	
					min	max		
09	22.5	29.5	17.00	09	16.5	2.49	5.94	13.50
11	22.5	29.5	20.00	11	20	3.90	5.94	13.50
13	24.0	30.5	23.00	13	23	4.83	8.33	16.30
15	25.5	31.5	26.30	15	27	6.60	11.61	20.00
17	27.5	33.5	29.30	17	30	7.19	15.60	20.00
19	29.3	36.0	32.30	19	33	8.26	16.10	20.00
21	34.3	40.5	37.30	21	36	8.71	17.73	22.50
23	34.3	40.5	40.30	23	39	9.68	20.90	26.50
25	34.3	40.5	43.30	25	42	10.62	21.67	29.50



M85049/ 39

M85049/ ① 39 ② - ③ 11 ④ N ⑤

- ① Serial No. : M85049/
- ② Terminal Shell Accessory Type : 39 – 90° cable clamp
- ③ No Code — non self-locking
S — self-locking
- ④ Shell No. : 09 11 13 15 17 19 21 23 25
- ⑤ Finish : A – black anodization
N – nickel plating
W – olive drab cadmium plating
S – stainless steel passivation
TT – titanium alloy electroless

Stereogram



Outline Dimension

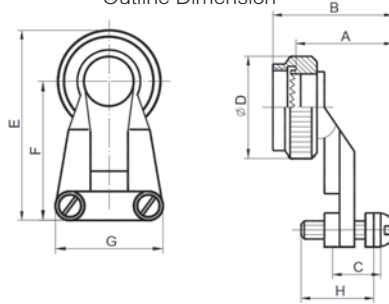

M 8 5 0 4 9 / 3 9 - [] [] [] [] [] []



Shell No.	A max	B max	Adpated Cable Diameter C		D max	E max	F max	G max	H	
09	26.0	33.5	2.49	5.94	09	16.5	26.00	19.00	16.50	13.50
11	26.0	33.5	3.90	5.94	11	20.0	29.00	20.00	19.50	13.50
13	30.0	33.5	4.83	8.33	13	23.0	34.00	24.00	22.50	16.30
15	31.0	34.5	6.60	11.61	15	27.0	38.00	26.00	26.00	20.00
17	31.5	35.0	7.19	15.60	17	30.0	41.00	27.00	29.00	20.00
19	32.0	35.5	8.26	16.10	19	33.0	46.00	31.00	32.00	20.00
21	33.0	36.5	8.71	17.74	21	36.0	49.00	32.00	37.00	22.50
23	35.0	38.5	9.68	20.90	23	39.0	54.00	36.00	40.00	26.50
25	35.0	38.5	10.62	21.67	25	42.0	59.00	39.00	43.00	29.50



Protective Cover

D38999/ 33 W 09 R
 ① ② ③ ④ ⑤

- ① Serial Code : D38999/
- ② Cover Style : 33 – use for receptacle; 32 – use for plug
- ③ Finish: F – Nickel plating
 W – olive drab cadmium plating
 K – stainless steel passivation
 TT – titanium alloy electroless
- ④ Shell No. : 09 11 13 15 17 19 21 23 25
- ⑤ Protective Cover Type : R – Stainless Steel Rigging with hole;
 N – Stainless Steel Rigging with loop;

Outline Dimension

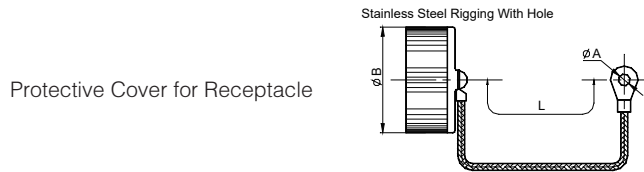

Shell No.	American Standard No.	A min	B max	L
09	D38999/33W09R	3.90	22.86	127.00
11	D38999/33W11R	3.90	27.96	127.00
13	D38999/33W13R	3.90	30.48	127.00
15	D38999/33W15R	3.90	31.75	127.00
17	D38999/33W17R	3.90	36.83	127.00
19	D38999/33W19R	3.90	38.10	127.00
21	D38999/33W21R	3.90	41.91	127.00
23	D38999/33W23R	3.90	44.45	127.00
25	D38999/33W25R	3.90	48.26	127.00

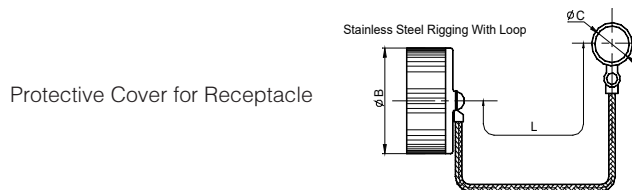

Shell No.	American Standard No.	C min	B max	L
09	D38999/33W09N	12.93	22.86	127.00
11	D38999/33W11N	17.78	27.96	127.00
13	D38999/33W13N	19.27	30.48	127.00
15	D38999/33W15N	22.60	31.75	127.00
17	D38999/33W17N	25.62	36.83	127.00
19	D38999/33W19N	36.27	38.10	127.00
21	D38999/33W21N	31.97	41.91	127.00
23	D38999/33W23N	42.62	44.45	127.00
25	D38999/33W25N	44.45	48.26	127.00



Outline Dimension

Protective Cover for Plug

Stainless Steel Rigging With Hole

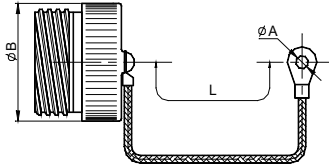

Shell No.	American Standard No.	A min	B max	L
09	D38999/32W09R	3.90	22.86	127.00
11	D38999/32W11R	3.90	27.96	127.00
13	D38999/32W13R	3.90	30.48	127.00
15	D38999/32W15R	3.90	31.75	127.00
17	D38999/32W17R	3.90	36.83	127.00
19	D38999/32W19R	3.90	38.10	127.00
21	D38999/32W21R	3.90	41.91	127.00
23	D38999/32W23R	3.90	44.45	127.00
25	D38999/32W25R	3.90	48.26	127.00

Protective Cover for Plug

Stainless Steel Rigging With Loop

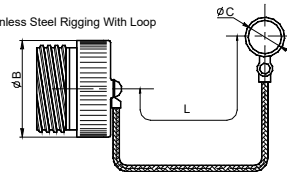

Shell No.	American Standard No.	C min	B max	L
09	D38999/32W09N	12.93	22.86	127.00
11	D38999/32W11N	17.78	27.96	127.00
13	D38999/32W13N	19.27	30.48	127.00
15	D38999/32W15N	22.60	31.75	127.00
17	D38999/32W17N	25.62	36.83	127.00
19	D38999/32W19N	28.95	38.10	127.00
21	D38999/32W21N	31.97	41.91	127.00
23	D38999/32W23N	34.03	44.45	127.00
25	D38999/32W25N	38.32	48.26	127.00



Contact Arrangement

View of Mating Face of Pin Insert

Series I Shell No.	Series III Shell No.	Series II Shell No.	Diagram	Condition	Diagram	Condition	Legend
09	09A	08		Condition M		Condition I	○ #22D contact ● #12 contact ● #8 coaxial contact ● #20 contact ● #12 coaxial Contact ● #8 triax contact ● #16 contact ● #10 contact
11	11B	10		Condition M		Condition II	
		10		Condition I		Condition I	
		10		Condition M			
13	13C	12		Condition M		Condition I	
		12		Condition M		Condition I	
15	15D	14		Condition M		Condition II	
		14		Condition I		Condition I	
		14		Condition M		Condition I	
		14		Condition I		Condition M	
17	17E	16		Condition M		Condition I	
		16		Condition I		Condition I	
		16		Condition I		Condition II	
		16		Condition M		Condition N	
		16		Condition N			

Note 1: They are all standard spectrum on this article

Note 2: we can design the spectrum with contacts #4, #6, and #8 according to customer requirement.

Note 3: It can't use in series II & Aerospace level glass-sinter connector when arrangement with #8 contacts.

Note 4: instructions: M-1300V, N-1000V, II-2300V

Note 5: The default terminal methods is crimp-fit on #8 point when the connector model with contact type PH, SH.



Contact Arrangement

■ View of Mating Face of Pin Insert

Series I Shell No.	Series III Shell No.	Series II Shell No.	Diagram 1	Diagram 2	Diagram 3	Diagram 4
19	19	18	35 Condition M 66#22D	11 Condition II 11#16	18 Condition M 4#8 14#22D	28 Condition I 2#16 26#20
			30 Condition I 1#16 29#20	32 Condition I 32#20	45 Condition M 17#22D 28#20	14 Condition I 6#12 8#20
			96 Condition I 9#12	<div style="display: flex; justify-content: space-around; align-items: center;"> <div style="text-align: center;">○ #22Dcontact</div> <div style="text-align: center;">● #12contact</div> <div style="text-align: center;">● #8coaxial contact</div> </div> <div style="display: flex; justify-content: space-around; align-items: center;"> <div style="text-align: center;">◐ #20contact</div> <div style="text-align: center;">● #12 coaxial contact</div> <div style="text-align: center;">◑ #8triax contact</div> </div> <div style="display: flex; justify-content: space-around; align-items: center;"> <div style="text-align: center;">◒ #16contact</div> <div style="text-align: center;">◓ #10contact</div> </div>		
21	21	20	35 Condition M 79#22D	11 Condition II 11#12	16 Condition II 16#16	24 Condition I 24#20
			25 Condition I 25#20	27 Condition I 27#20	39 Condition I 2#16 37#20	41 Condition I 41#20
			75 Condition I 4#8	29 Condition I 3#12 26#20	02 Condition M 79#22D	04 Condition N 4#10
			05 Condition N 5#10			
23	23	22	35 Condition M 100#22D	21 Condition II 21#16	32 Condition I 32#20	34 Condition I 34#20

Note 1: They are all standard spectrum on this article

Note 2: We can design the spectrum with contacts #4, #6, and #8 according to customer requirement.

Note 3: It can't use in series II & Aerospace level glass-sinter connector when arrangement with #8 contacts.



Note 4: Instructions : M-1300V, N-1000V, II-2300V

Note 5: The default terminal methods is crimp-fit on #8 point when the connector model with contact type PH, SH.

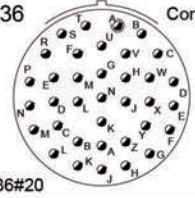
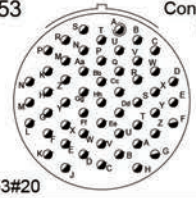
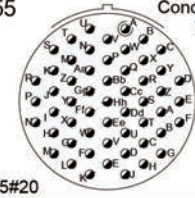
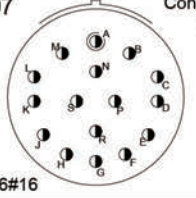

Contact Arrangement

■ View of Mating Face of Pin Insert

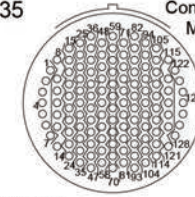
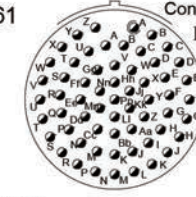
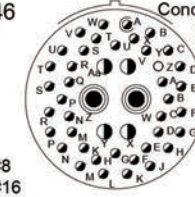
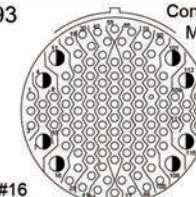
Series I Shell No.	Series III Shell No.	Series II Shell No.	Diagram	Condition	Diagram	Condition	Diagram	Condition		
23	23 H	22		Condition I		Condition I		Condition I		
			36#20		53#20		55#20			Condition I
			99	Condition II	39a	Condition N				
			11#16		4#8 35#22D					
25	25 J	24		Condition M		Condition I		Condition I		
			128#22D		61#20		2#8 4#16 40#20			Condition M
			20	Condition N	29	Condition I	19	Condition I	69	Condition I
			3#8 4#12 13#16 10#20		29#16		19#12		10#16 15#20 44#22D	
			04	Condition I	08	Condition I	43	Condition I	50	Condition M
			8#16 48#20		8#8		20#16 23#20		6#12 11#16 33#22D	
			24	Condition I	11	Condition M	22a	Condition M		
			12#12 12#16		9#10 2#20		22#12			

Note 1: They are all standard spectrum on this article

Note 2: We can design the spectrum with contacts #4, #6, and #8 according to customer requirement.

Note 3: It can't use in series II & Aerospace level glass-sinter connector when arrangement with #8 contacts.

Note 4: Instructions : M-1300V, N-1000V, II-2300V

Note 5: The default terminal methods is crimp-fit on #8 point when the connector model with contact type PH, SH.



Contact Arrangement on PCB

relevant shell No change to 08,10,12.....that is series II PCB contact arrangement

hole diameter on PCB, #22D contact min diameter is 0.99mm, #20contacts min diameter is 1mm, #16 contact min diameter is 1.3mm. (just for reference) contacts identification sign–front view for pin insulation board Coordinate Units:mm

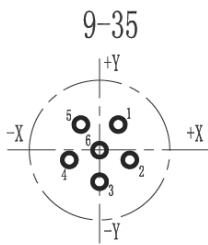

Contact	Coordinate	
	X	Y
1	+1.14	+1.98
2	+1.98	-1.14
3	0.00	-2.29
4	-1.98	-1.14
5	-1.14	+1.98
6	0.00	0.00

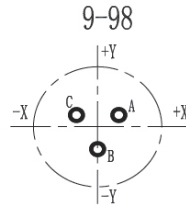

Contact	Coordinate	
	X	Y
A	+1.65	+0.97
B	0.00	-1.91
C	-1.65	+0.97

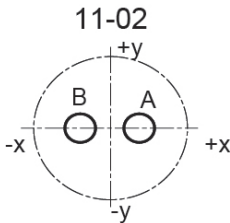

Contact	Coordinate	
	X	Y
A	+2.41	0.00
B	-2.41	0.00

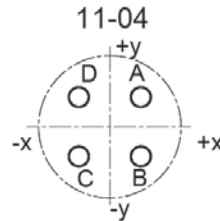

Contact	Coordinate	
	X	Y
A	+1.65	+1.65
B	+1.65	-1.65
C	-1.65	-1.65
D	-1.65	+1.65

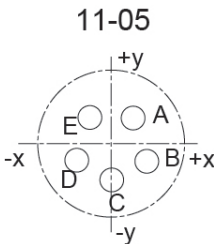

Contact	Coordinate	
	X	Y
A	+1.65	+1.42
B	+2.87	-1.65
C	0.00	-3.30
D	-2.87	-1.65
E	-1.65	+1.42

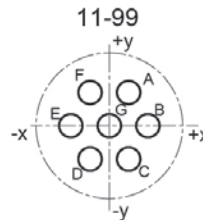

Contact	Coordinate	
	X	Y
A	+1.65	+2.87
B	+3.30	0.00
C	+1.65	-2.87
D	-1.65	-2.87
E	-3.30	0.00
F	-1.65	+2.87
G	0.00	0.00

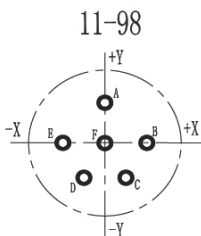

Contact	Coordinate	
	X	Y
A	0.00	+3.30
B	+3.30	0.00
C	+1.65	-2.87
D	-1.65	-2.87
E	-3.30	0.00
F	0.00	0.00

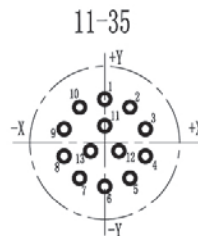

Contact	Coordinate	
	X	Y
1	0.00	+3.71
2	+2.16	+3.00
3	+3.51	+1.14
4	+3.51	-1.14
5	+2.16	-3.00
6	0.00	-3.71
7	-2.16	-3.00
8	-3.51	-1.14
9	-3.51	+1.14
10	-2.16	+3.00
11	0.00	+1.42
12	+1.24	-0.90
13	-1.24	-0.90

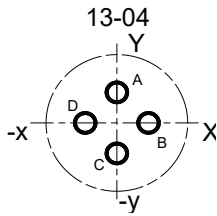

Contact	Coordinate	
	X	Y
A	0.00	+3.81
B	+3.71	+0.90
C	0.00	-2.11
D	-3.71	+0.90

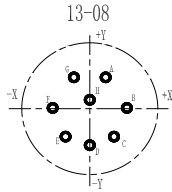

Contact	Coordinate		Contact	Coordinate	
	X	Y		X	Y
A	+1.65	+3.99	E	-3.05	-3.05
B	+4.32	0.00	F	-4.32	0.00
C	+3.05	-3.05	G	-1.65	+3.99
D	0.00	-4.32	H	0.00	+1.12

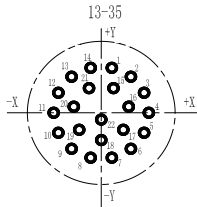

Contact	Coordinate		Contact	Coordinate		Contact	Coordinate	
	X	Y		X	Y		X	Y
1	+1.14	+5.00	9	-3.20	-4.01	17	+2.36	-1.91
2	+3.20	+4.01	10	-4.62	-2.24	18	0.00	-3.05
3	+4.62	+2.24	11	-5.16	0.00	19	-2.36	-1.91
4	+5.16	0.00	12	-4.62	+2.24	20	-2.97	+0.66
5	+4.62	-2.24	13	-3.20	+4.01	21	-1.14	+2.72
6	+3.20	-4.01	14	-1.14	+5.00	22	0.00	-0.76
7	+1.14	-5.00	15	+1.14	+2.72			
8	-1.14	-5.00	16	+2.97	+0.66			

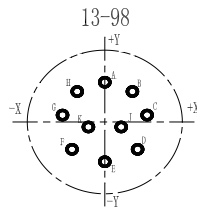

Contact	Coordinate		Contact	Coordinate	
	X	Y		X	Y
A	0.00	+4.95	F	-4.17	-2.67
B	+3.18	+3.81	G	-4.90	+0.76
C	+4.90	+0.76	H	-3.18	+3.81
D	+4.17	-2.67	J	+1.65	-0.38
E	0.00	-3.43	K	-1.65	-0.38

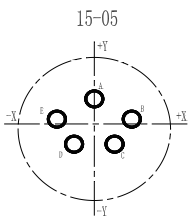

Contact	Coordinate	
	X	Y
A	0.00	+2.54
B	+4.42	+0.61
C	+2.39	-3.76
D	-2.39	-3.76
E	-4.42	+0.61

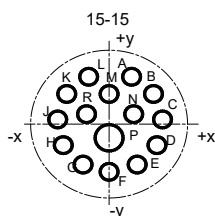

Contact	Coordinate		Contact	Coordinate	
	X	Y		X	Y
A	+2.54	+5.72	J	-6.20	+0.36
B	+5.13	+3.56	K	-5.13	+3.56
C	+6.20	+0.36	L	-2.54	+5.72
D	+5.54	-2.87	M	0.00	+3.56
E	+3.20	-5.31	N	+2.79	+1.02
F	0.00	-6.22	P	0.00	-1.96
G	-3.20	-5.31	R	-2.79	+1.02
H	-5.54	-2.87			

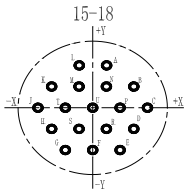

Contact	Coordinate		Contact	Coordinate		Contact	Coordinate	
	X	Y		X	Y		X	Y
A	+1.65	+6.40	H	-4.95	-2.87	R	+1.65	-2.87
B	+4.95	+2.87	J	-6.60	0.00	S	-1.65	-2.87
C	+6.60	0.00	K	-4.95	+2.87	T	-3.30	0.00
D	+4.95	-2.87	L	-1.65	+6.40	U	0.00	0.00
E	+3.30	-5.72	M	-1.65	+2.87			
F	0.00	-5.72	N	+1.65	+2.87			
G	-3.30	-5.72	P	+3.30	0.00			

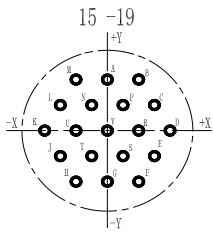

Contact	Coordinate		Contact	Coordinate		Contact	Coordinate	
	X	Y		X	Y		X	Y
A	0.00	+5.72	H	-3.30	-5.72	R	+3.30	0.00
B	+3.30	+5.72	J	-4.95	-2.87	S	+1.65	-2.87
C	+4.95	+2.87	K	-6.60	0.00	T	-1.65	-2.87
D	+6.60	0.00	L	-4.95	+2.87	U	-3.30	0.00
E	+4.95	-2.87	M	-3.30	+5.72	V	0.00	0.00
F	+3.30	-5.72	N	-1.65	+2.87			
G	0.00	-5.72	P	+1.65	+2.87			

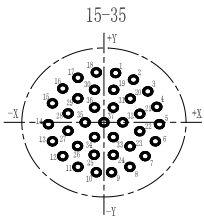

Contact	Coordinate		Contact	Coordinate		Contact	Coordinate	
	X	Y		X	Y		X	Y
1	+1.14	+6.65	14	-6.76	-0.25	27	-4.32	-1.27
2	+3.12	+5.51	15	-6.45	+2.03	28	-4.32	+1.02
3	+5.36	+4.06	16	-5.36	+4.06	29	-3.12	+3.02
4	+6.45	+2.03	17	-3.12	+5.51	30	-1.14	+4.37
5	+6.76	-0.25	18	-1.14	+6.65	31	+1.14	+1.88
6	+6.27	-2.49	19	+1.14	+4.37	32	+2.29	-0.10
7	+5.08	-4.45	20	+3.12	+3.02	33	+1.14	-2.08
8	+3.30	-5.90	21	+4.32	+1.02	34	-1.14	-2.08
9	+1.14	-6.65	22	+4.32	-1.27	35	-2.29	-0.10
10	-1.14	-6.65	23	+3.12	-3.23	36	-1.14	+1.88
11	-3.30	-5.90	24	+1.14	-4.37	37	0.00	-0.10
12	-5.08	-4.45	25	-1.14	-4.37			
13	-6.27	-2.49	26	-3.12	-3.23			

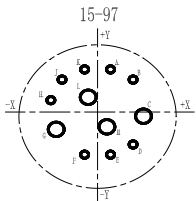

Contact	Coordinate		Contact	Coordinate	
	X	Y		X	Y
A	+1.65	+5.94	G	-5.26	-2.41
B	+4.52	+4.52	H	-5.94	+1.65
C	+5.84	-0.58	J	-4.52	+4.52
D	+4.52	-4.52	K	-1.65	+5.94
E	+1.65	-5.94	L	-1.19	+2.06
F	-2.26	-5.97	M	+1.19	-2.06

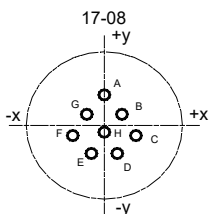

Contact	Coordinate	
	X	Y
A	0.00	+5.99
B	+3.25	+2.18
C	+5.84	-1.98
D	+2.39	-5.49
E	-2.39	-5.49
F	-5.84	-1.98
G	-3.25	+2.18
H	0.00	-1.32

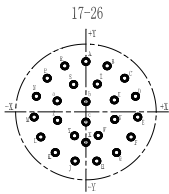

Contact	Coordinate		Contact	Coordinate		Contact	Coordinate	
	X	Y		X	Y		X	Y
A	0.00	+8.15	K	-4.80	-6.60	V	+4.53	-0.91
B	+3.33	+7.44	L	-7.06	-4.09	W	+3.02	-3.84
C	+6.07	+5.44	M	-8.10	-0.86	X	0.00	-5.16
D	+7.75	+2.51	N	-7.75	+2.51	Y	-3.02	-3.84
E	+8.10	-0.86	P	-6.07	+5.44	Z	-4.53	-0.91
F	+7.06	-4.09	R	-3.33	+7.44	a	-4.45	+2.39
G	+4.80	-6.60	S	-1.78	+4.50	b	0.00	+1.65
H	+1.70	-7.98	T	+1.78	+4.50	c	0.00	-1.65
J	-1.70	-7.98	U	+4.45	+2.39			

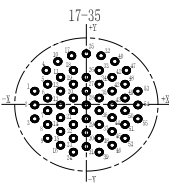

Contact	Coordinate		Contact	Coordinate		Contact	Coordinate	
	X	Y		X	Y		X	Y
1	-7.92	+2.18	20	-1.98	+1.04	39	+1.98	-8.10
2	-7.92	-0.10	21	-1.98	-1.24	40	+4.37	+7.09
3	-7.92	-2.39	22	-1.98	-3.53	41	+3.96	+4.47
4	-6.15	+5.61	23	-1.98	-5.82	42	+3.96	+2.18
5	-5.94	+3.33	24	-1.98	-8.10	43	+3.96	-0.10
6	-5.94	+1.04	25	0.00	+8.36	44	+3.96	-2.39
7	-5.94	-1.24	26	0.00	+4.47	45	+3.96	-4.67
8	-5.94	-3.53	27	0.00	+2.18	46	+3.96	-6.96
9	-5.94	-5.82	28	0.00	-0.10	47	+6.15	+5.61
10	-4.37	+7.09	29	0.00	-2.39	48	+5.94	+3.33
11	-3.96	+4.47	30	0.00	-4.67	49	+5.94	+1.04
12	-3.96	+2.18	31	0.00	-6.96	50	+5.94	-1.24
13	-3.96	-0.10	32	+2.26	+8.03	51	+5.94	-3.53
14	-3.96	-2.39	33	+1.98	+5.61	52	+5.94	-5.82
15	-3.96	-4.67	34	+1.98	+3.33	53	+7.92	+2.18
16	-3.96	-6.96	35	+1.98	+1.04	54	+7.92	-0.10
17	-2.26	+8.03	36	+1.98	-1.24	55	+7.92	-2.39
18	-1.98	+5.61	37	+1.98	-3.53			
19	-1.98	+3.33	38	+1.98	-5.82			

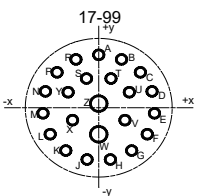

Contact	Coordinate		Contact	Coordinate		Contact	Coordinate	
	X	Y		X	Y		X	Y
A	0.00	+8.15	J	-1.70	-7.98	T	+1.78	+4.50
B	+3.33	+7.44	K	-4.80	-6.60	U	+4.45	+2.39
C	+6.07	+5.44	L	-7.06	-4.09	V	+3.81	-1.91
D	+7.75	+2.51	M	-8.10	-0.86	W	0.00	-4.09
E	+8.10	-0.86	N	-7.75	+2.51	X	-3.81	-1.91
F	+7.06	-4.09	P	-6.07	+5.44	Y	-4.45	+2.39
G	+4.80	-6.60	R	-3.33	+7.44	Z	0.00	+0.64
H	+1.70	-7.98	S	-1.78	+4.50			

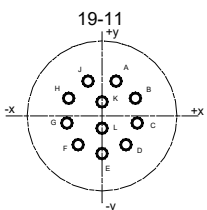

Contact	Coordinate		Contact	Coordinate	
A	+2.67	+6.60	G	-6.99	-1.35
B	+6.35	+3.35	H	-6.35	+3.35
C	+6.99	-1.35	J	-2.67	+6.60
D	+4.55	-5.46	K	0.00	+2.67
E	0.00	-7.14	L	0.00	-2.34
F	-4.55	-5.46			

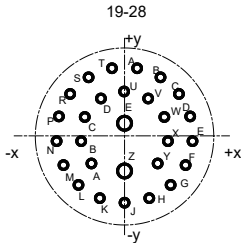

Contact	Coordinate		Contact	Coordinate		Contact	Coordinate	
	X	Y		X	Y		X	Y
A	+1.68	+8.97	L	-6.15	-6.73	X	+5.79	-0.84
B	+4.80	+7.75	M	-8.15	-4.06	Y	+4.42	-3.84
C	+7.26	+5.51	N	-9.07	-0.84	Z	0.00	-4.85
D	+8.76	+2.49	P	-8.76	+2.41	a	-4.42	-3.84
E	+9.07	-0.84	R	-7.26	+5.51	b	-5.79	-0.84
F	+8.15	-4.06	S	-4.80	+7.75	c	-5.31	+2.41
G	+6.15	-6.73	T	-1.68	+8.97	d	-3.15	+4.90
H	+3.30	-8.51	U	0.00	+5.84	e	0.00	+1.57
J	0.00	-9.12	V	+3.15	+4.90			
K	-3.30	-8.51	W	+5.31	+2.41			

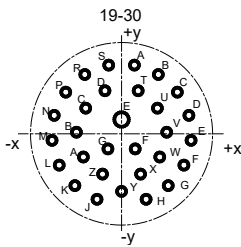

Contact	Coordinate		Contact	Coordinate		Contact	Coordinate	
	X	Y		X	Y		X	Y
A	+1.65	+8.79	L	-8.00	-4.01	X	+2.44	-5.16
B	+4.72	+7.59	M	-8.92	-0.84	Y	0.00	-7.37
C	+7.16	+5.33	N	-8.64	+2.36	Z	-2.44	-5.16
D	+8.64	+2.36	P	-7.16	+5.33	a	-4.90	-2.97
E	+8.92	-0.84	R	-4.72	+7.59	b	-5.79	+0.20
F	+8.00	-4.01	S	-1.65	+8.79	c	-4.60	+3.28
G	+5.99	-6.63	T	+2.13	+5.51	d	-2.13	+5.51
H	+3.15	-8.38	U	+4.60	+3.28	e	0.00	+1.83
J	-3.15	-8.38	V	+5.79	+0.20	f	+1.75	-1.93
K	-5.99	-6.63	W	+4.90	-2.97	g	-1.75	-1.93

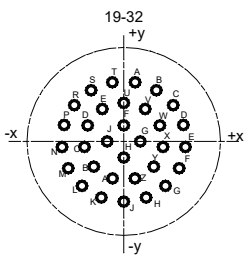

Contact	Coordinate		Contact	Coordinate		Contact	Coordinate	
	X	Y		X	Y		X	Y
A	+1.68	+8.97	M	-8.15	-4.06	Z	+1.65	-5.61
B	+4.80	+7.75	N	-9.07	-0.84	a	-1.65	-5.61
C	+7.26	+5.51	P	-8.76	+2.49	b	-4.42	-3.84
D	+8.76	+2.49	R	-7.26	+5.51	c	-5.79	-0.84
E	+9.07	-0.84	S	-4.80	+7.75	d	-5.31	+2.41
F	+8.15	-4.06	T	-1.68	+8.97	e	-3.15	+4.90
G	+6.15	-6.73	U	0.00	+5.84	f	0.00	+2.44
H	+3.30	-8.51	V	+3.15	+4.90	g	+2.44	0.00
J	0.00	-9.12	W	+5.31	+2.41	h	0.00	-2.44
K	-3.30	-8.51	X	+5.79	-0.80	j	-2.44	0.00
L	-6.15	-6.73	Y	+4.42	-3.84			

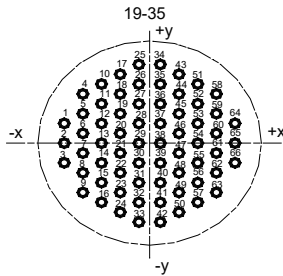

Contact	Coordinate		Contact	Coordinate		Contact	Coordinate	
	X	Y		X	Y		X	Y
1	-9.07	+2.29	23	-3.12	-5.72	45	+3.12	+3.43
2	-9.07	0.00	24	-3.12	-8.00	46	+3.12	+1.14
3	-9.07	-2.29	25	-1.14	+9.14	47	+3.12	-1.14
4	-7.09	+5.72	26	-1.14	+6.86	48	+3.12	-3.43
5	-7.09	+3.43	27	-1.14	+4.57	49	+3.12	-5.72
6	-7.09	+1.14	28	-1.14	+2.29	50	+3.12	-8.00
7	-7.09	-1.14	29	-1.14	0.00	51	+5.11	+6.86
8	-7.09	-3.43	30	-1.14	-2.29	52	+5.11	+4.57
9	-7.09	-5.72	31	-1.14	-4.57	53	+5.11	+2.29
10	-5.11	+6.86	32	-1.14	-6.86	54	+5.11	0.00
11	-5.11	+4.57	33	-1.14	-9.14	55	+5.11	-2.29
12	-5.11	+2.29	34	+1.14	+9.14	56	+5.11	-4.57
13	-5.11	0.00	35	+1.14	+6.86	57	+5.11	-6.86
14	-5.11	-2.29	36	+1.14	+4.57	58	+7.09	+5.72
15	-5.11	-4.57	37	+1.14	+2.29	59	+7.09	+3.43
16	-5.11	-6.86	38	+1.14	0.00	60	+7.09	+1.14
17	-3.12	+8.00	39	+1.14	-2.29	61	+7.09	-1.14
18	-3.12	+5.72	40	+1.14	-4.57	62	+7.09	-3.43
19	-3.12	+3.43	41	+1.14	-6.86	63	+7.09	-5.72
20	-3.12	+1.14	42	+1.14	-9.14	64	+9.07	+2.29
21	-3.12	-1.14	43	+3.12	+8.00	65	+9.07	0.00
22	-3.12	-3.43	44	+3.12	+5.72	66	+9.07	-2.29

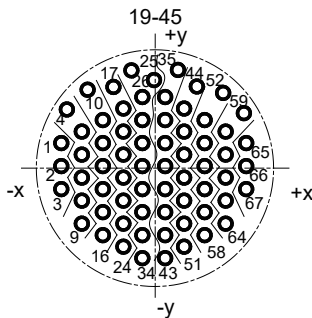

Contact	Coordinate		Contact	Coordinate		Contact	Coordinate	
	X	Y		X	Y		X	Y
1	-9.07	+2.06	24	-3.12	-8.23	47	+3.12	+0.91
2	-9.07	-0.23	25	-2.24	+9.14	48	-3.12	-1.37
3	-9.07	-2.51	26	0.00	+8.61	49	+3.12	-3.66
4	-7.72	+5.41	27	-1.14	+6.63	50	+3.12	-5.94
5	-7.09	+3.20	28	-1.14	+4.34	51	+3.12	-8.23
6	-7.09	+0.91	29	-1.14	+2.06	52	+6.20	+7.11
7	-7.09	-1.37	30	-1.14	-0.23	53	+5.11	+4.34
8	-7.09	-3.66	31	-1.14	-2.51	54	+5.11	+2.06
9	-7.09	-5.94	32	-1.14	-4.80	55	+5.11	-0.23
10	-6.20	+7.11	33	-1.14	-7.09	56	+5.11	-2.51
11	-5.11	+4.34	34	-1.14	-9.37	57	+5.11	-4.80
12	-5.11	+2.06	35	+2.24	+9.14	58	+5.11	-7.09
13	-5.11	-0.23	36	+1.14	+6.61	59	+7.72	+5.41
14	-5.11	-2.51	37	+1.14	+4.34	60	+7.09	+3.20
15	-5.11	-4.80	38	+1.14	+2.06	61	+7.09	+0.91
16	-5.11	-7.09	39	+1.14	-0.23	62	+7.09	-1.37
17	-3.96	+7.65	40	+1.14	-2.51	63	+7.09	-3.66
18	-3.12	+5.49	41	+1.14	-4.80	64	+7.09	-5.94
19	-3.12	+3.20	42	+1.14	-7.09	65	+9.07	+2.06
20	-3.12	+0.91	43	+1.14	-9.37	66	+9.07	-0.23
21	-3.12	-1.37	44	+3.96	+7.65	67	+9.07	-2.51
22	-3.12	-3.66	45	+3.12	+5.49			
23	-3.12	-5.94	46	+3.12	+3.20			



21-16

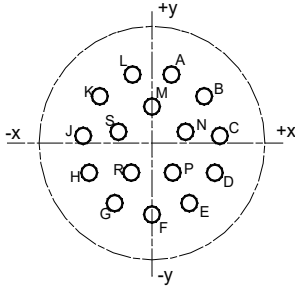

Contact	Coordinate		Contact	Coordinate		Contact	Coordinate	
	X	Y		X	Y		X	Y
A	+3.00	+8.18	G	-4.62	-7.37	N	+3.91	+1.57
B	+6.88	+5.36	H	-7.82	-3.81	P	+2.39	-3.10
C	+8.66	+0.91	J	-8.66	+0.91	R	-2.39	-3.10
D	+7.82	-3.81	K	-6.88	+5.36	S	-3.91	+1.57
E	+4.62	-7.37	L	-3.00	+8.18			
F	0.00	-8.71	M	0.00	+4.45			

21-24

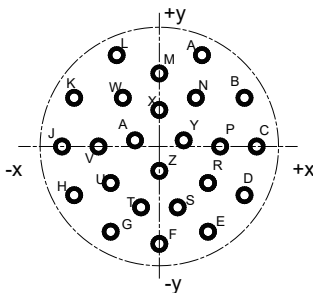

Contact	Coordinate		Contact	Coordinate		Contact	Coordinate	
	X	Y		X	Y		X	Y
A	+4.45	+9.53	J	-10.16	0.00	T	-1.91	-6.35
B	+8.90	+5.08	K	-8.90	+5.08	U	-5.08	-3.81
C	+10.16	0.00	L	-4.45	+9.53	V	-6.35	0.00
D	+8.90	-5.08	M	0.00	+7.62	W	-3.81	+5.08
E	+5.08	-8.90	N	+3.81	+5.08	X	0.00	+3.81
F	0.00	-10.16	P	+6.35	0.00	Y	+2.54	+0.64
G	-5.08	-8.90	R	+5.08	-3.81	Z	0.00	-2.54
H	-8.90	-5.08	S	+1.91	-6.35	a	-2.54	+0.64

21-25

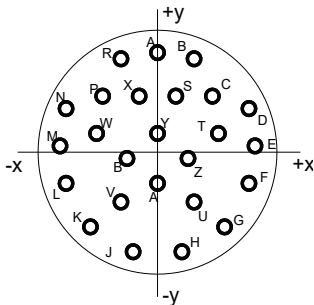

Contact	Coordinate		Contact	Coordinate		Contact	Coordinate	
	X	Y		X	Y		X	Y
A	0.00	+10.16	K	-6.99	-7.62	V	-3.81	-5.08
B	+3.81	+9.53	L	-9.53	-3.18	W	-6.35	+1.91
C	+5.72	+5.72	M	-10.16	+0.64	X	-1.91	+5.72
D	+9.53	+4.45	N	-9.53	+4.45	Y	0.00	+1.91
E	+10.16	+0.64	P	-5.72	+5.72	Z	+3.18	-0.64
F	+9.53	-3.18	R	-3.81	+9.53	a	0.00	-3.18
G	+6.99	-7.62	S	+1.91	+5.72	b	-3.18	-0.64
H	+2.54	-10.16	T	+6.35	+1.91			
J	-2.54	-10.16	U	+3.81	-5.08			

21-27

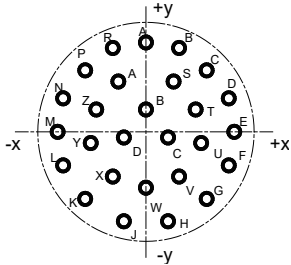

Contact	Coordinate		Contact	Coordinate		Contact	Coordinate	
	X	Y		X	Y		X	Y
A	0.00	+10.16	K	-6.99	-7.62	V	+3.81	-5.08
B	+3.81	+9.53	L	-9.53	-3.81	W	0.00	-6.35
C	+6.99	+6.99	M	-10.16	0.00	X	-3.81	-5.08
D	+9.53	+3.81	N	-9.53	+3.81	Y	-6.35	+3.81
E	+10.16	0.00	P	-6.99	+6.99	Z	-5.72	+2.54
F	+9.53	-3.81	R	-3.81	+9.53	a	-3.18	+5.72
G	+6.99	-7.62	S	+3.18	+5.72	b	0.00	+2.54
H	+2.54	-10.16	T	+5.72	+2.54	c	+2.54	-0.64
J	-2.54	-10.16	U	+6.35	-1.27	d	-2.54	-0.64

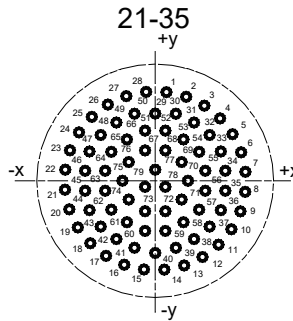

Contact	Coordinate		Contact	Coordinate		Contact	Coordinate		Contact	Coordinate	
	X	Y		X	Y		X	Y		X	Y
1	+1.35	+10.82	21	-10.85	-1.22	41	-2.49	-8.18	61	-3.40	-5.05
2	+3.71	+10.26	22	-10.85	+1.22	42	-4.67	-7.11	62	-5.28	-3.53
3	+5.90	+9.19	23	-10.31	+3.58	43	-6.55	-5.59	63	-6.02	-1.22
4	+7.77	+7.67	24	-9.27	+5.77	44	-7.90	-3.58	64	-6.02	+1.22
5	+9.27	+5.77	25	-7.77	+7.67	45	-8.43	-1.22	65	-5.28	+3.53
6	+10.31	+3.58	26	-5.90	+9.19	46	-8.43	+1.22	66	-3.40	+5.05
7	+10.85	+1.22	27	-3.71	+10.26	47	-7.90	+3.58	67	-1.22	+3.71
8	+10.85	-1.22	28	-1.35	+10.82	48	-6.55	+5.59	68	+1.22	+3.71
9	+10.31	-3.58	29	0.00	+8.20	49	-4.67	+7.11	69	+3.18	+2.29
10	+9.27	-5.77	30	+2.49	+8.18	50	-2.49	+8.18	70	+3.94	0.00
11	+7.77	-7.67	31	+4.67	+7.11	51	-1.22	+6.12	71	+3.18	-2.29
12	+5.90	-9.19	32	+6.55	+5.59	52	+1.22	+6.12	72	+1.22	-3.71
13	+3.71	-10.26	33	+7.90	+3.58	53	+3.40	+5.05	73	-1.22	-3.71
14	+1.35	-10.82	34	+8.43	+1.22	54	+5.28	+3.53	74	-3.18	-2.29
15	-1.35	-10.82	35	+8.43	-1.22	55	+6.02	+1.22	75	-3.94	0.00
16	-3.71	-10.26	36	+7.90	-3.58	56	+6.02	-1.22	76	-3.18	+2.29
17	-5.90	-9.19	37	+6.55	-5.59	57	+5.28	-3.53	77	0.00	+1.35
18	-7.77	-7.67	38	+4.67	-7.11	58	+3.40	-5.05	78	+1.22	-0.74
19	-9.27	-5.77	39	+2.49	-8.18	59	+1.22	-6.12	79	-1.22	-0.74
20	-10.31	-3.58	40	0.00	-8.81	60	-1.22	-6.12			

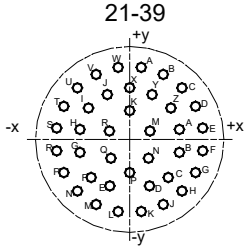

Contact	Coordinate		Contact	Coordinate		Contact	Coordinate	
	X	Y		X	Y		X	Y
A	+1.65	+10.44	P	-9.42	-4.80	d	+2.84	-6.73
B	+4.80	+9.42	R	-10.44	-1.65	e	-2.84	-6.73
C	+7.47	+7.47	S	-10.44	+1.65	f	-5.51	-4.80
D	+9.42	+4.80	T	-9.42	+4.80	g	-7.11	-1.88
E	+10.44	+1.65	U	-7.47	+7.47	h	-7.11	+1.45
F	+10.44	-1.65	V	-4.80	+9.42	i	-5.90	+4.55
G	+9.42	-4.80	W	-1.65	+10.44	j	-3.20	+6.50
H	+7.47	-7.47	X	0.00	+7.49	k	0.00	+4.17
J	+4.80	-9.42	Y	+3.20	+6.50	m	+2.90	+1.22
K	+1.65	-10.44	Z	+5.90	+4.55	n	+2.69	-2.72
L	-1.65	-10.44	a	+7.11	+1.45	p	0.00	-4.80
M	-4.80	-9.42	b	+7.11	-1.88	q	-2.69	-2.72
N	-7.47	-7.47	c	+5.51	-4.80	r	-2.90	+1.22

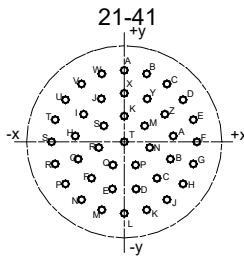

Contact	Coordinate		Contact	Coordinate		Contact	Coordinate	
	X	Y		X	Y		X	Y
A	0.00	+10.60	R	-10.09	-3.28	f	-4.78	-5.39
B	+3.28	+10.09	S	-10.60	0.00	g	-6.73	-2.55
C	+6.23	+8.58	T	-10.09	+3.28	h	-7.15	+0.87
D	+8.58	+6.23	U	-8.58	+6.23	i	-5.92	+4.09
E	+10.09	+3.28	V	-6.23	+8.58	j	-3.35	+6.38
F	+10.60	0.00	W	-3.28	+10.09	k	0.00	+3.81
G	+10.09	-3.28	X	0.00	+7.20	m	+2.98	+2.38
H	+8.58	-6.23	Y	+3.35	+6.38	n	+3.71	-0.85
J	+6.23	-8.58	Z	+5.92	+4.09	p	+1.66	-3.43
K	+3.28	-10.09	a	+7.15	+0.87	q	-1.66	-3.43
L	0.00	-10.60	b	+6.73	-2.55	r	-3.71	-0.85
M	-3.28	-10.09	c	+4.78	-5.39	s	-2.98	+2.38
N	-6.23	-8.58	d	+1.73	-6.99	t	0.00	0.00
P	-8.58	-6.23	e	-1.73	-6.99			

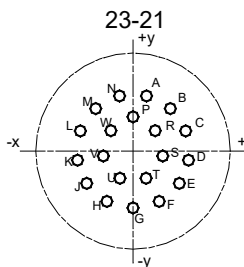

Contact	Coordinate		Contact	Coordinate		Contact	Coordinate	
	X	Y		X	Y		X	Y
A	+3.25	+9.78	H	-4.65	-9.19	R	+4.06	+3.71
B	+7.34	+7.24	J	-8.33	-6.07	S	+5.44	-0.90
C	+9.80	+3.12	K	-10.16	-1.65	T	+2.39	-4.93
D	+10.16	-1.65	L	-9.80	+3.12	U	-2.39	-4.93
E	+8.33	-6.07	M	-7.34	+7.24	V	-5.44	-0.90
F	+4.65	-9.19	N	-3.25	+9.78	W	-4.06	+3.71
G	0.00	-10.31	P	0.00	+6.22	X	0.00	0.00

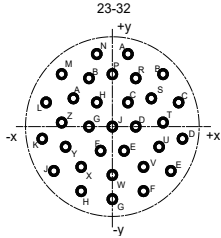

Contact	Coordinate		Contact	Coordinate		Contact	Coordinate	
	X	Y		X	Y		X	Y
A	+2.54	+11.43	M	-8.26	+8.26	Z	-8.26	+0.64
B	+8.26	+8.26	N	-2.54	+11.43	a	-6.35	+4.45
C	+10.80	+3.81	P	0.00	+8.26	b	-3.81	+7.62
D	+11.43	-1.91	R	+3.81	+7.62	c	+2.54	+3.81
E	+9.53	-6.99	S	+6.35	+4.45	d	+3.81	0.00
F	+5.08	-10.16	T	+8.26	+0.64	e	+1.91	-3.81
G	0.00	-11.43	U	+7.62	-3.18	f	-1.91	-3.81
H	-5.08	-10.16	V	+5.08	-6.35	g	-3.81	0.00
J	-9.53	-6.99	W	0.00	-7.62	h	-2.54	+3.81
K	-11.43	-1.91	X	-5.08	-6.35	j	0.00	0.00
L	-10.80	+3.81	Y	-7.62	-3.18			

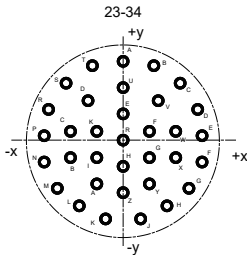

Contact	Coordinate		Contact	Coordinate		Ccontact	Coordinate	
	X	Y		X	Y		X	Y
A	0.00	+11.43	N	+11.43	-3.18	b	-7.62	-2.54
B	+4.45	+10.80	P	-11.43	+0.64	c	-7.62	+1.27
C	+8.26	+8.26	R	-10.80	+4.45	d	-5.08	+5.72
D	+10.80	+4.45	S	-8.26	+8.26	e	0.00	+3.81
E	+11.43	+0.64	T	-4.45	+10.80	f	+3.81	+1.27
F	+11.43	-3.18	U	0.00	+7.62	g	+3.81	-2.54
G	+9.53	-6.99	V	+5.08	+5.72	h	0.00	-3.81
H	+6.35	-9.53	W	+7.62	+1.27	i	-3.81	-2.54
J	+2.54	-11.43	X	+7.62	-2.54	k	-3.81	+1.27
K	-2.54	-11.43	Y	+3.81	-6.35	r	0.00	0.00
L	-6.35	-9.53	Z	0.00	-7.62			
M	-9.53	-6.99	a	-3.81	-6.35			

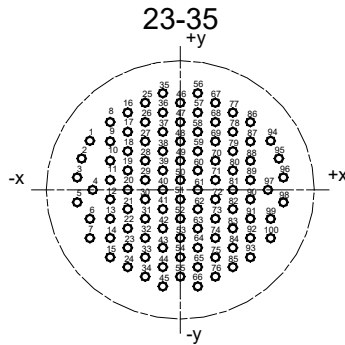

Contact	Coordinate		Contact	Coordinate		Contact	Coordinate		Contact	Coordinate		Contact	Coordinate	
	X	Y		X	Y		X	Y		X	Y		X	Y
1	-10.87	+6.12	21	-6.32	-2.41	41	-2.11	-2.41	61	+2.11	0.00	81	+6.32	0.00
2	-11.86	+3.91	22	-6.32	-4.83	42	-2.11	-4.83	62	+2.11	-2.41	82	+6.32	-2.41
3	-12.40	+1.55	23	-6.32	-7.24	43	-2.11	-7.24	63	+2.11	-4.83	83	+6.32	-4.83
4	-10.54	0.00	24	-6.32	-9.65	44	-2.11	-9.65	64	+2.11	-7.24	84	+6.32	-7.24
5	-12.40	-1.55	25	-4.22	+10.87	45	-2.11	-12.07	65	+2.11	-9.65	85	+6.32	-9.65
6	-10.87	-3.61	26	-4.22	+8.46	46	0.00	+10.87	66	+2.11	-12.07	86	+8.43	+8.46
7	-10.87	-6.02	27	-4.22	+6.05	47	0.00	+8.46	67	+4.22	+10.87	87	+8.43	+6.05
8	-8.43	+8.46	28	-4.22	+3.63	48	0.00	+6.05	68	+4.22	+8.46	88	+8.43	+3.63
9	-8.43	+6.05	29	-4.22	+1.22	49	0.00	+3.63	69	+4.22	+6.05	90	+8.43	+1.22
10	-8.43	+3.63	30	-4.22	-1.19	50	0.00	+1.22	70	+4.22	+3.63	90	+8.43	-1.19
11	-8.43	+1.22	31	-4.22	-3.61	51	0.00	-1.19	71	+4.22	+1.22	91	+8.43	-3.61
12	-8.43	-1.19	32	-4.22	-6.02	52	0.00	-3.61	72	+4.22	-1.19	92	+8.43	-6.02
13	-8.43	-3.61	33	-4.22	-8.43	53	0.00	-6.02	73	+4.22	-3.61	93	+8.43	-8.43
14	-8.43	-6.02	34	-4.22	-10.85	54	0.00	-8.43	74	+4.22	-6.02	94	+10.87	+6.12
15	-8.43	-8.43	35	-2.11	+12.07	55	0.00	-10.85	75	+4.22	-8.43	95	+11.86	+3.91
16	-6.32	+9.65	36	-2.11	+9.65	56	+2.11	+12.07	76	+4.22	-10.85	96	+12.40	+1.55
17	-6.32	+7.24	37	-2.11	+7.24	57	+2.11	+9.65	77	+6.32	+9.65	97	+10.54	0.00
18	-6.32	+4.83	38	-2.11	+4.83	58	+2.11	+7.24	78	+6.32	+7.24	98	+12.40	-1.55
19	-6.32	+2.41	39	-2.11	+2.41	59	+2.11	+4.83	79	+6.32	+4.83	99	+10.87	-3.61
20	-6.32	0.00	40	-2.11	0.00	60	+2.11	+2.41	80	+6.32	+2.41	100	+10.87	-6.02



21-39

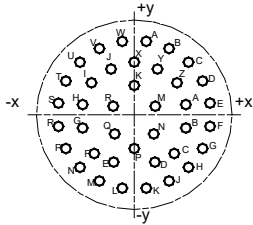

Contact	Coordinate		Contact	Coordinate		Contact	Coordinate	
	X	Y		X	Y		X	Y
A	+1.65	+10.44	P	-9.42	-4.80	d	+2.84	-6.73
B	+4.80	+9.42	R	-10.44	-1.65	e	-2.84	-6.73
C	+7.47	+7.47	S	-10.44	+1.65	f	-5.51	-4.80
D	+9.42	+4.80	T	-9.42	+4.80	g	-7.11	-1.88
E	+10.44	+1.65	U	-7.47	+7.47	h	-7.11	+1.45
F	+10.44	-1.65	V	-4.80	+9.42	i	-5.90	+4.55
G	+9.42	-4.80	W	-1.65	+10.44	j	-3.20	+6.50
H	+7.47	-7.47	X	0.00	+7.49	k	0.00	+4.17
J	+4.80	-9.42	Y	+3.20	+6.50	m	+2.90	+1.22
K	+1.65	-10.44	Z	+5.90	+4.55	n	+2.69	-2.72
L	-1.65	-10.44	a	+7.11	+1.45	p	0.00	-4.80
M	-4.80	-9.42	b	+7.11	-1.88	q	-2.69	-2.72
N	-7.47	-7.47	c	+5.51	-4.80	r	-2.90	+1.22

21-41

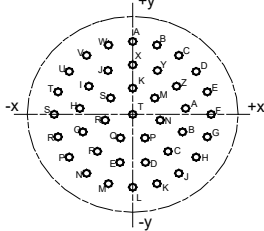

Contact	Coordinate		Contact	Coordinate		Contact	Coordinate	
	X	Y		X	Y		X	Y
A	0.00	+10.60	R	-10.09	-3.28	f	-4.78	-5.39
B	+3.28	+10.09	S	-10.60	0.00	g	-6.73	-2.55
C	+6.23	+8.58	T	-10.09	+3.28	h	-7.15	+0.87
D	+8.58	+6.23	U	-8.58	+6.23	i	-5.92	+4.09
E	+10.09	+3.28	V	-6.23	+8.58	j	-3.35	+6.38
F	+10.60	0.00	W	-3.28	+10.09	k	0.00	+3.81
G	+10.09	-3.28	X	0.00	+7.20	m	+2.98	+2.38
H	+8.58	-6.23	Y	+3.35	+6.38	n	+3.71	-0.85
J	+6.23	-8.58	Z	+5.92	+4.09	p	+1.66	-3.43
K	+3.28	-10.09	a	+7.15	+0.87	q	-1.66	-3.43
L	0.00	-10.60	b	+6.73	-2.55	r	-3.71	-0.85
M	-3.28	-10.09	c	+4.78	-5.39	s	-2.98	+2.38
N	-6.23	-8.58	d	+1.73	-6.99	t	0.00	0.00
P	-8.58	-6.23	e	-1.73	-6.99			

23-21

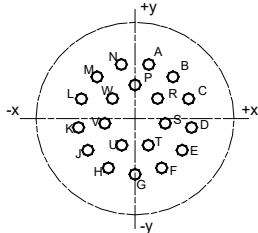

Contact	Coordinate		Contact	Coordinate		Contact	Coordinate	
	X	Y		X	Y		X	Y
A	+3.25	+9.78	H	-4.65	-9.19	R	+4.06	+3.71
B	+7.34	+7.24	J	-8.33	-6.07	S	+5.44	-0.90
C	+9.80	+3.12	K	-10.16	-1.65	T	+2.39	-4.93
D	+10.16	-1.65	L	-9.80	+3.12	U	-2.39	-4.93
E	+8.33	-6.07	M	-7.34	+7.24	V	-5.44	-0.90
F	+4.65	-9.19	N	-3.25	+9.78	W	-4.06	+3.71
G	0.00	-10.31	P	0.00	+6.22	X	0.00	0.00

23-32

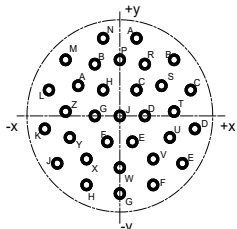

Contact	Coordinate		Contact	Coordinate		Contact	Coordinate	
	X	Y		X	Y		X	Y
A	+2.54	+11.43	M	-8.26	+8.26	Z	-8.26	+0.64
B	+8.26	+8.26	N	-2.54	+11.43	a	-6.35	+4.45
C	+10.80	+3.81	P	0.00	+8.26	b	-3.81	+7.62
D	+11.43	-1.91	R	+3.81	+7.62	c	+2.54	+3.81
E	+9.53	-6.99	S	+6.35	+4.45	d	+3.81	0.00
F	+5.08	-10.16	T	+8.26	+0.64	e	+1.91	-3.81
G	0.00	-11.43	U	+7.62	-3.18	f	-1.91	-3.81
H	-5.08	-10.16	V	+5.08	-6.35	g	-3.81	0.00
J	-9.53	-6.99	W	0.00	-7.62	h	-2.54	+3.81
K	-11.43	-1.91	X	-5.08	-6.35	j	0.00	0.00
L	-10.80	+3.81	Y	-7.62	-3.18			

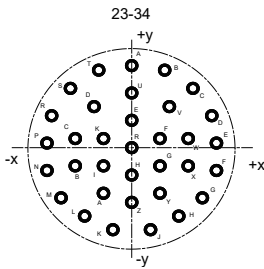

Contact	Coordinate		Contact	Coordinate		Contact	Coordinate	
	Y	X		X	Y		X	Y
A	0.00	+11.43	N	+11.43	-3.18	b	-7.62	-2.54
B	+4.45	+10.80	P	-11.43	+0.64	c	-7.62	+1.27
C	+8.26	+8.26	R	-10.80	+4.45	d	-5.08	+5.72
D	+10.80	+4.45	S	-8.26	+8.26	e	0.00	+3.81
E	+11.43	+0.64	T	-4.45	+10.80	f	+3.81	+1.27
F	+11.43	-3.18	U	0.00	+7.62	g	+3.81	-2.54
G	+9.53	-6.99	V	+5.08	+5.72	h	0.00	-3.81
H	+6.35	-9.53	W	+7.62	+1.27	i	-3.81	-2.54
J	+2.54	-11.43	X	+7.62	-2.54	k	-3.81	+1.27
K	-2.54	-11.43	Y	+3.81	-6.35	r	0.00	0.00
L	-6.35	-9.53	Z	0.00	-7.62			
M	-9.53	-6.99	a	-3.81	-6.35			

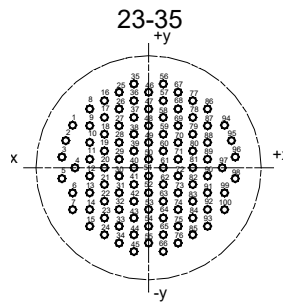

Contact	Coordinate		Contact	Coordinate		Contact	Coordinate		Contact	Coordinate		Contact	Coordinate	
	X	Y		X	Y		X	Y		X	Y		X	Y
1	-10.87	+6.12	21	-6.32	-2.41	41	-2.11	-2.41	61	+2.11	0.00	81	+6.32	0.00
2	-11.86	+3.91	22	-6.32	-4.83	42	-2.11	-4.83	62	+2.11	-2.41	82	+6.32	-2.41
3	-12.40	+1.55	23	-6.32	-7.24	43	-2.11	-7.24	63	+2.11	-4.83	83	+6.32	-4.83
4	-10.54	0.00	24	-6.32	-9.65	44	-2.11	-9.65	64	+2.11	-7.24	84	+6.32	-7.24
5	-12.40	-1.55	25	-4.22	+10.87	45	-2.11	-12.07	65	+2.11	-9.65	85	+6.32	-9.65
6	-10.87	-3.61	26	-4.22	+8.46	46	0.00	+10.87	66	+2.11	-12.07	86	+8.43	+8.46
7	-10.87	-6.02	27	-4.22	+6.05	47	0.00	+8.46	67	+4.22	+10.87	87	+8.43	+6.05
8	-8.43	+8.46	28	-4.22	+3.63	48	0.00	+6.05	68	+4.22	+8.46	88	+8.43	+3.63
9	-8.43	+6.05	29	-4.22	+1.22	49	0.00	+3.63	69	+4.22	+6.05	90	+8.43	+1.22
10	-8.43	+3.63	30	-4.22	-1.19	50	0.00	+1.22	70	+4.22	+3.63	90	+8.43	-1.19
11	-8.43	+1.22	31	-4.22	-3.61	51	0.00	-1.19	71	+4.22	+1.22	91	+8.43	-3.61
12	-8.43	-1.19	32	-4.22	-6.02	52	0.00	-3.61	72	+4.22	-1.19	92	+8.43	-6.02
13	-8.43	-3.61	33	-4.22	-8.43	53	0.00	-6.02	73	+4.22	-3.61	93	+8.43	-8.43
14	-8.43	-6.02	34	-4.22	-10.85	54	0.00	-8.43	74	+4.22	-6.02	94	+10.87	+6.12
15	-8.43	-8.43	35	-2.11	+12.07	55	0.00	-10.85	75	+4.22	-8.43	95	+11.86	+3.91
16	-6.32	+9.65	36	-2.11	+9.65	56	+2.11	+12.07	76	+4.22	-10.85	96	+12.40	+1.55
17	-6.32	+7.24	37	-2.11	+7.24	57	+2.11	+9.65	77	+6.32	+9.65	97	+10.54	0.00
18	-6.32	+4.83	38	-2.11	+4.83	58	+2.11	+7.24	78	+6.32	+7.24	98	+12.40	-1.55
19	-6.32	+2.41	39	-2.11	+2.41	59	+2.11	+4.83	79	+6.32	+4.83	99	+10.87	-3.61
20	-6.32	0.00	40	-2.11	0.00	60	+2.11	+2.41	80	+6.32	+2.41	100	+10.87	-6.02

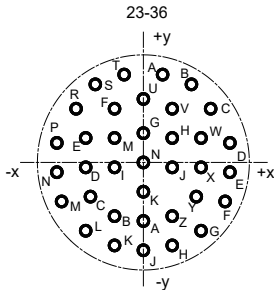

Contact	Coordinate		Contact	Coordinate		Contact	Coordinate	
	X	Y		X	Y		X	Y
A	+2.54	+11.43	N	-11.43	-1.27	b	-3.81	-6.99
B	+6.35	+10.16	P	-11.43	+2.54	c	-6.99	-4.45
C	+8.90	+6.99	R	-8.90	+6.69	d	-7.62	-0.64
D	+11.43	+2.54	S	-6.35	+10.16	e	-7.62	+3.18
E	+11.43	-1.27	T	-2.54	+11.43	f	-3.81	+6.69
F	+10.80	-5.08	U	0.00	+8.26	g	0.00	+3.81
G	+7.62	-8.90	V	+3.81	+6.99	h	+3.81	+3.18
H	+3.81	-10.80	W	+7.62	+3.18	j	+3.81	-0.64
J	0.00	-11.43	X	+7.62	-0.64	k	0	-3.81
K	-3.81	-10.80	Y	+6.99	-4.45	i	-3.81	-0.64
L	-7.62	-8.90	Z	+3.81	-6.99	m	-3.81	+3.18
M	-10.80	-5.08	a	0.00	-7.62	n	0.00	0.00

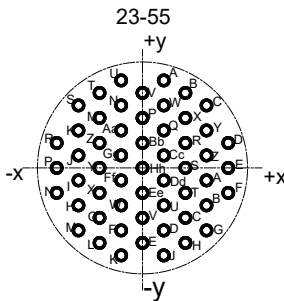

Contact	Coordinate		Contact	Coordinate		Contact	Coordinate	
	X	Y		X	Y		X	Y
A	+2.84	+11.56	W	+2.84	+8.26	r	+5.72	+3.30
B	+5.72	+9.91	X	+5.72	+6.60	s	+5.72	0.00
C	+8.53	+8.26	Y	+8.53	+4.95	t	+5.72	-3.30
D	+11.43	+3.30	Z	+8.53	+1.65	u	+2.84	-4.95
E	+11.43	0.00	a	+8.53	-1.65	v	0.00	-6.60
F	+11.43	-3.30	b	+8.53	-4.95	w	-2.84	-4.95
G	+8.53	-8.26	c	+5.72	-6.60	x	-5.72	-3.30
H	+5.72	-9.91	d	+2.84	-8.26	y	-5.72	0.00
J	+2.84	-11.56	e	0.00	-9.91	z	-5.72	+3.30
K	-2.84	-11.56	f	-2.84	-8.26	AA	-2.84	+4.95
L	-5.72	-9.91	g	-5.72	-6.60	BB	0.00	+3.30
M	-8.53	-8.26	h	-8.53	-4.95	CC	+2.84	+1.65
N	-11.43	-3.30	i	-8.53	-1.65	DD	+2.84	-1.65
P	-11.43	0.00	j	-8.53	+1.65	EE	0.00	-3.30
R	-11.43	+3.30	k	-8.53	+4.95	FF	-2.84	-1.65
S	-8.53	+8.26	m	-5.72	+6.60	GG	-2.84	+1.65
T	-5.72	+9.91	n	-2.84	+8.26	HH	0.00	0.00
U	-2.84	+11.56	p	0.00	+6.60			
V	0.00	+9.91	q	+2.84	+4.95			

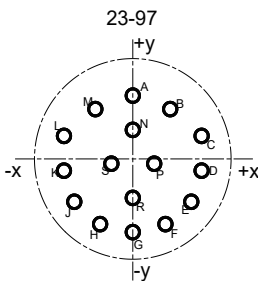

Contact	Coordinate		Contact	Coordinate		Contact	Coordinate	
	X	Y		X	Y		X	Y
A	0.00	+8.74	G	0.00	-10.31	N	0.00	+3.96
B	+5.33	+6.86	H	-4.65	-9.19	P	+3.05	-0.76
C	+9.80	+3.12	J	-8.33	-6.07	R	0.00	-5.54
D	+10.16	-1.65	K	-10.16	-1.65	S	-3.05	-0.76
E	+8.33	-6.07	L	-9.80	+3.12			
F	+4.65	-9.19	M	-5.33	+6.86			

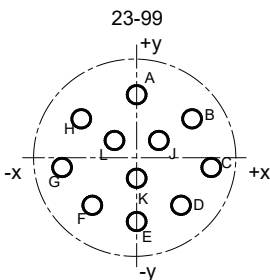

Contact	Coordinate		Contact	Coordinate	
	X	Y		X	Y
A	0.00	+10.26	G	-10.26	0.00
B	+7.62	+6.86	H	-7.62	+6.86
C	+10.26	0.00	J	+3.05	+3.81
D	+6.10	-5.33	K	0.00	-1.52
E	0.00	-7.62	L	-3.05	+3.81
F	-6.10	-5.33			

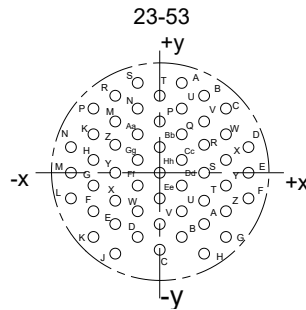

Contact	Coordinate		Contact	Coordinate		Contact	Coordinate	
	X	Y		X	Y		X	Y
A	+2.84	+11.56	W	+8.53	+4.95	t	+5.72	-3.30
B	+5.72	+9.91	X	+8.53	+1.65	u	+2.84	-4.95
C	+8.53	+8.26	Y	+8.53	-1.65	v	0.00	-6.60
D	+11.43	+3.30	Z	+8.53	-4.95	w	-2.84	-4.95
E	+11.43	0.00	a	+5.72	-6.60	x	-5.72	-3.30
F	+11.43	-3.30	b	+2.84	-8.26	y	-5.72	0.00
G	+8.53	-8.26	c	0.00	-9.91	z	-5.72	+3.30
H	+5.72	-10.41	d	-2.84	-8.26	AA	-2.84	+4.95
J	-5.72	-10.41	e	-5.72	-6.60	BB	0.00	+3.30
K	-8.53	-8.26	f	-8.53	-4.95	CC	+2.84	+1.65
L	-11.43	-3.30	g	-8.53	-1.65	DD	+2.84	-1.65
M	-11.43	0.00	h	-8.53	+1.65	EE	0.00	-3.30
N	-11.43	+3.30	k	-8.53	+4.95	FF	-2.84	-1.65
P	-8.53	+8.26	m	-5.72	+6.60	GG	-2.84	+1.65
R	-5.72	+9.91	n	-2.84	+8.26	HH	0.00	0.00
S	-2.84	+11.56	p	0.00	+6.60			
T	0.00	+9.91	q	+2.84	+4.95			
U	+2.84	+8.26	r	+5.72	+3.30			
V	+5.72	+6.60	s	+5.72	0.00			

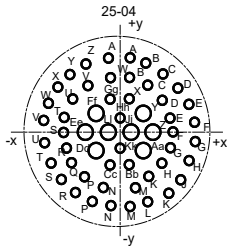

Contact	Coordinate		Contact	Coordinate		Contact	Coordinate	
	X	Y		X	Y		X	Y
A	+1.75	+13.49	W	-12.52	+5.21	t	-9.58	+3.35
B	+5.16	+12.57	X	-10.77	+8.28	u	-7.90	+6.38
C	+8.23	+10.80	Y	-8.23	+10.80	v	-5.38	+8.74
D	+10.77	+8.28	Z	-5.16	+12.57	w	-2.18	+10.08
E	+12.52	-5.21	a	-1.75	+13.49	x	+1.75	+6.68
F	+13.49	+1.75	b	+2.18	+10.08	y	+4.37	+3.78
G	+13.49	-1.75	c	+5.38	+8.74	z	+6.55	0.00
H	+12.52	-5.21	d	+7.90	+6.38	AA	+4.37	-3.78
J	+10.77	-8.28	e	+9.58	+3.35	BB	+1.75	-6.68
K	+8.23	10.80	f	+10.46	0.00	CC	-1.75	-6.68
L	+5.16	-12.57	g	+9.58	-3.35	DD	-4.37	-3.78
M	+1.75	-13.49	h	+7.90	-6.38	EE	-6.55	0.00
N	-1.75	-13.39	k	+5.38	-8.74	FF	-4.37	+3.78
P	-5.16	-12.57	m	+2.18	-10.08	GG	-1.75	+6.68
R	-8.23	-10.80	n	-2.18	-10.08	HH	0.00	+3.35
S	-10.77	-8.28	p	-5.38	-8.74	JJ	+2.18	0.00
T	-12.52	-5.21	q	-7.90	-6.38	KK	0.00	-3.35
U	-13.49	-1.75	r	-9.58	-3.35	LL	-2.18	0.00
V	-13.49	+1.75	s	-10.46	0.00			

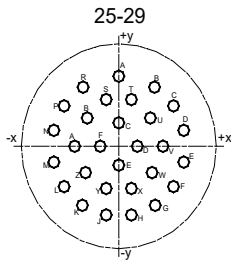

Contact	Coordinate		Contact	Coordinate		Contact	Coordinate	
	X	Y		X	Y		X	Y
A	0.00	+12.22	L	-10.03	-7.04	X	+2.31	-7.37
B	+6.55	+10.31	M	-11.91	-2.77	Y	-2.31	-7.37
C	+10.03	+7.04	N	-11.91	+2.77	Z	-6.10	-4.60
D	+11.91	+2.77	P	-10.03	+7.04	a	-8.10	0.00
E	+11.91	-2.77	R	-6.55	+10.31	b	-5.79	+4.93
F	+10.03	-7.04	S	-2.31	+8.15	c	0.00	+4.09
G	+6.68	-10.31	T	+2.31	+8.15	d	+3.40	0.00
H	+2.31	-11.99	U	+5.79	+4.93	e	0.00	-3.30
J	-2.31	-11.99	V	+8.10	0.00	f	-3.40	0.00
K	-6.68	-10.31	W	+6.10	-4.60			

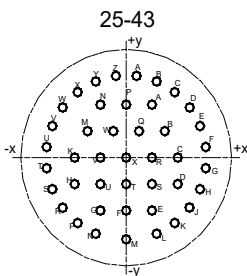

Contact	Coordinate		Contact	Coordinate		Contact	Coordinate	
	X	Y		X	Y		X	Y
A	+1.75	+13.49	S	-12.52	-5.21	h	-8.74	-4.37
B	+5.16	+12.57	T	-13.49	-1.75	k	-8.74	0.00
C	+8.23	+10.80	U	-13.49	+1.75	m	-6.55	+4.37
D	+10.77	+8.28	V	-12.52	+5.21	n	-4.37	+8.74
E	+12.52	+5.21	W	-10.77	+8.28	p	0.00	+8.74
F	+13.49	+1.75	X	-8.23	+10.80	q	+2.18	+4.37
G	+13.49	-1.75	Y	-5.16	+12.57	r	+4.37	0.00
H	+12.52	-5.21	Z	-1.75	+13.49	s	+4.37	-4.37
J	+10.77	-8.28	a	+4.37	+8.74	t	-0.00	-4.37
K	+8.23	-10.80	b	+6.55	+4.37	u	-4.37	-4.37
L	+5.16	-12.57	c	+8.74	0.00	v	-4.37	0.00
M	0.00	-13.49	d	+8.74	-4.37	w	-2.18	+4.37
N	-5.16	-12.57	e	+4.37	-8.74	x	0.00	0.00
P	-8.23	-10.80	f	0.00	-8.74			
R	-10.77	-8.28	g	-4.37	-8.74			



25-35

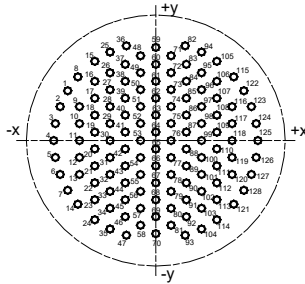

Contact	Coordinate		Contact	Coordinate		Contact	Coordinate		Contact	Coordinate	
	X	Y		X	Y		X	Y		X	Y
1	-12.17	+7.09	33	-6.32	-7.24	65	0.00	-1.19	97	+6.32	+4.83
2	-13.21	+4.83	34	-6.32	-9.65	66	0.00	-3.61	98	+6.32	+2.41
3	-13.87	+2.41	35	-6.32	-12.07	67	0.00	-6.02	99	+6.32	0.00
4	-14.10	0.00	36	-4.06	+13.49	68	0.00	-8.43	100	+6.32	-2.41
5	-13.87	-2.41	37	-4.22	+10.85	69	0.00	-10.85	101	+6.32	-4.83
6	-13.21	-4.83	38	-4.22	+8.43	70	0.00	-14.10	102	+6.32	-7.24
7	-12.17	-7.09	39	-4.22	+6.02	71	+2.11	+12.07	103	+6.32	-9.65
8	-10.77	+9.07	40	-4.22	+3.61	72	+2.11	+9.65	104	+6.32	-12.07
9	-10.54	+4.83	41	-4.22	+1.19	73	+2.11	+7.24	105	+8.43	+11.28
10	-10.54	+2.41	42	-4.22	-1.19	74	+2.11	+4.83	106	+8.43	+8.43
11	-10.54	0.00	43	-4.22	-3.61	75	+2.11	+2.41	107	+8.43	+6.02
12	-10.54	-2.41	44	-4.22	-6.02	76	+2.11	0.00	108	+8.43	+3.61
13	-10.54	-4.83	45	-4.22	-8.43	77	+2.11	-2.41	109	+8.43	+1.19
14	-10.77	-9.07	46	-4.22	-10.85	78	+2.11	-4.83	110	+8.43	-1.19
15	-8.43	+11.28	47	-4.22	-13.26	79	+2.11	-7.24	111	+8.43	-3.61
16	-8.43	+8.43	48	-2.11	+12.07	80	+2.11	-9.65	112	+8.43	-6.02
17	-8.43	+6.02	49	-2.11	+9.65	81	+2.11	-12.07	113	+8.43	-8.43
18	-8.43	+3.61	50	-2.11	+7.24	82	+4.06	+13.49	114	+8.43	-10.85
19	-8.43	+1.19	51	-2.11	+4.83	83	+4.22	+10.85	115	+10.77	+9.07
20	-8.43	-1.19	52	-2.11	+2.41	84	+4.22	+8.43	116	+10.54	+4.83
21	-8.43	-3.61	53	-2.11	0.00	85	+4.22	+6.02	117	+10.54	+2.41
22	-8.43	-6.02	54	-2.11	-2.41	86	+4.22	+3.61	118	+10.54	0.00
23	-8.43	-8.43	55	-2.11	-4.83	87	+4.22	+1.19	119	+10.54	-2.41
24	-8.43	-10.85	56	-2.11	-7.24	88	+4.22	-1.19	120	+10.54	-4.83
25	-6.32	+12.60	57	-2.11	-9.65	90	+4.22	-3.61	121	+10.77	-9.07
26	-6.32	+9.65	58	-2.11	-12.07	90	+4.22	-6.02	122	+12.17	+7.09
27	-6.32	+7.24	59	0.00	+13.26	91	+4.22	-8.43	123	+13.21	+4.83
28	-6.32	+4.83	60	0.00	+10.85	92	+4.22	-10.85	124	+13.87	+2.41
29	-6.32	+2.41	61	0.00	+8.43	93	+4.22	-13.26	125	+14.10	0.00
30	-6.32	0.00	62	0.00	+6.02	94	+6.32	+12.60	126	+13.87	-2.41
31	-6.32	-2.41	63	0.00	+3.61	95	+6.32	+9.65	127	+13.21	-4.83
32	-6.32	-4.83	64	0.00	+1.19	96	+6.32	+7.24	128	+12.17	-7.09

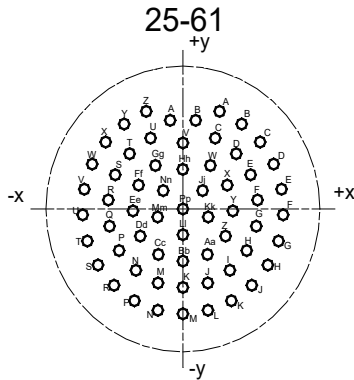

Contact	Coordinate		Contact	Coordinate		Contact	Coordinate	
	X	Y		X	Y		X	Y
A	+4.98	+12.70	Y	-7.98	+11.05	v	0.00	+8.59
B	+7.98	+11.05	Z	-4.98	+12.70	w	+3.73	+5.66
C	+10.49	+8.71	a	-1.73	+11.53	x	+6.02	+3.10
D	+12.32	+5.84	b	+1.73	+11.53	y	+6.78	-0.25
E	+13.39	+2.57	c	+4.39	+9.22	z	+5.79	-3.53
F	+13.61	-0.76	d	+7.24	+7.19	AA	+3.33	-5.92
G	+12.98	-4.17	e	+9.19	+4.45	BB	0.00	-6.78
H	+11.53	-7.29	f	+10.13	+1.17	CC	-3.33	-5.92
J	+9.35	-9.93	g	+9.96	+2.24	DD	-5.79	-3.53
K	+6.58	+11.94	h	+8.66	-5.41	EE	-6.78	-0.25
L	+3.40	-13.18	i	+6.38	-7.98	FF	-6.02	+3.10
M	0.00	-13.64	j	+3.38	-9.63	GG	-3.73	+5.66
N	-3.40	-13.18	k	0.00	-10.21	HH	0.00	+5.08
P	-6.58	-11.94	m	-3.38	-9.63	JJ	+2.67	+2.39
R	-9.35	-9.93	n	-6.38	-7.98	KK	+3.43	-1.04
S	-11.53	-7.29	p	-8.66	-5.41	LL	0.00	-3.35
T	-12.98	-4.17	q	-9.96	-2.24	MM	-3.43	-1.04
U	-13.61	-0.76	r	-10.13	+1.17	NN	-2.67	+2.39
V	-13.39	+2.57	s	-9.19	+4.45	PP	0.00	0.00
W	-12.32	+5.84	t	-7.24	+7.19			
X	-10.49	+8.71	u	-4.39	+9.22			

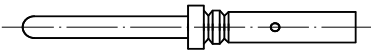
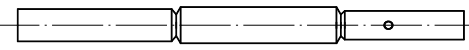
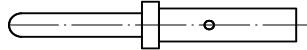
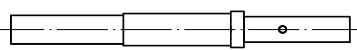
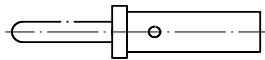
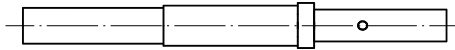
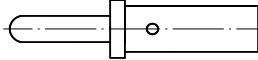
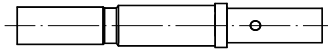
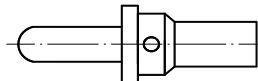
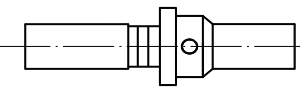
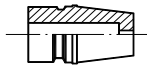

Label Contact Diagram

Contact No.	Contact Type	Standard Parts No.	Contact Diagram
#22d	Pin	J1216/58-360	
	Socket	J1216/56-348	
#20	Pin	J1216/58-363	
	Socket	J1216/56-351	
#16	Pin	J1216/58-364	
	Socket	J1216/56-352	
#12	Pin	J1216/58-365	
	Socket	J1216/56-353	
#8	Pin	——	
	Socket	——	
	Sleeve (1)	——	

If only sealing sleeve, need to order separately.



Coaxial Contact Figure

Contact No.	Contact Type	Standard Parts No.	Contact Diagram
#16 Coaxial	Pin	J1216/76-424	
	Socket	J1216/77-428	
#12 Coaxial	Pin	J1216/28-211 ⁽¹⁾	
	Socket	J1216/75-416 ⁽¹⁾	
#8 Coaxial	Pin	J1216/60-367	
	Socket	J1216/59-366	
	Sleeve	_____	
#8 Triax	Pin	J1216/90-529	
	Socket	J1216/91-530	
	Sleeve	_____	



Press- it Contact Dimensions

Contact No.	Contact Style	Pin Head Diameter φ mm	Cable Section Area				Wire Insulating Outer Diameter	
			AWG		mm2		min	max
			min	max	min	max		
#22D	pin / socket	0.76	26	22	0.13	0.33	0.76	1.37
#20	pin / socket	1.02	24	20	0.21	0.52	1.02	2.11
#16	pin / socket	1.59	20	16	0.52	1.31	1.65	2.77
#12	pin / socket	2.39	14	12	2.08	3.31	2.46	3.61
#8	pin / socket	3.61	—	8	—	8.37	4.50	6.50
#16 coaxial	pin / socket	1.59	SFF-50-1.5-1		SYV-50-2-1		1.65	2.60
#12 coaxial	pin / socket	2.39	SFF-50-1.5-1		SYV-50-2-1		2.40	2.60
#8 coaxial	pin / socket	5.54	SFF-95-3				—	2.80
#8 triax	pin / socket	5.54	SEFF-78-1-51				3.15	3.40

Note: The sleeve TY7.854.001 for sealing on #8 contact need to separate order.

