

# R066 Series Electric Rectangular Connector

## Brief Introduction

- Contact spacing: 1.905mm
- Contact arrangements and contact no.:
- 2 rows: 10, 20, 30, 40, 50, 60, 70, 80, 90, 100pins
- 3 rows: 11, 23, 35, 47, 59, 71, 80, 92, 104, 122, 140, 152, 182, 206pins
- 4 rows: 86, 110, 164, 196, 204, 220, 250, 276, 300, 404pins
- 6 rows: 162, 204, 252, 300, 360, 402pins
- Termination type: solder contact, straight to PCB, right angle to PCB, SMT and wire wrap, etc.
- Meet standard of MIL-C-55302

## Specification

- Rate current(max): 3A
- Environment temperature: -65°C ~ +125°C
- Dielectric strength: 750V
- Durability: 500 times
- Contact resistance:  $\leq 15m\Omega$
- Insulation resistance  $\geq 5000M\Omega$
- Vibration: 10Hz ~ 2000Hz, 147m/s<sup>2</sup>
- Shock: 980 m/s<sup>2</sup>, 6ms

## How to order

R066    -    2    1    2    -    010    -    10    1    -    6800  
 ①            ②    ③    ④            ⑤            ⑥    ⑦            ⑧

- ① Serial number: R066
- ② Row no.: 2/3/4/6 rows
- ③ Connector structure:

product	plug	code	receptacle	code
R066 2rows& 3rows	straight to PCB (with mounting ears)	1	straight to PCB (with mounting ears)	2
	straight to PCB (w/o mounting ears)	3	straight to PCB (w/o mounting ears)	4
	right angle to PCB (with mounting ears)	5	right angle to PCB (with mounting ears)	6
	right angle to PCB (w/o mounting ears)	7	right angle to PCB (w/o mounting ears)	8
R066 4 rows	straight to PCB (with mounting ears)	1	straight to PCB (with mounting ears)	2
	right angle to PCB (with mounting ears)	5	right angle to PCB (with mounting bracket)	6
R066 6 rows	straight to PCB (with mounting ears)	3	straight to PCB (w/o mounting ears)	4
	right angle to PCB (with mounting ears)	7	right angle to PCB (with mounting bracket)	8

- ④ Insulator material: 2-PPS (polyphenylene sulfide)
- ⑤ Contact no.: 2 rows: 010, 020, 030, 040, 050, 060, 070, 080, 090, 100 pins  
 3 rows: 11, 23, 35, 47, 59, 71, 80, 92, 104, 122, 140, 152, 182, 206pins  
 4 rows: 86, 110, 164, 196, 204, 220, 250, 276, 300, 404pins  
 6 rows: 162, 204, 252, 300, 360, 402pins
- ⑥ Termination type ,please see page 2nd
- ⑦ Contact finish: 1- gold plating; 2- solder dip (available with straight to PCB and right angle to PCB)
- ⑧ Hardware style, please see pages 36th-37th.



## R066 Series Electric Rectangular Connector

### Contact and termination type ( for 2 rows & 3 rows connectors)

pin (for plug)	code	socket (for receptacle)	code
bend solder dip 2.77 × φ 0.5	10	solder dip 2.77 × φ 0.5	20
solder cup (inner dia.): φ 0.7	11	solder dip 3.56 × φ 0.5	21
solder dip 3.56 × φ 0.5	12	solder dip 4.37 × φ 0.5	22
solder dip 4.37 × φ 0.5	13	solder cup(inner dia.): φ 0.7	24
bend solder dip 2.77 × φ 0.5	31	wire wrap 12.7 × □0.46	26
bend solder dip 3.56 × φ 0.5	32	wire wrap 9.53 × □0.46	27
bend solder dip 4.37 × φ 0.5	33	wire wrap 15.88 × □0.46	28
bend solder dip 2.77 × φ 0.4	34	bend solder dip 2.77 × φ 0.5	44
bend solder dip 3.56 × φ 0.4	35	bend solder dip 3.56 × φ 0.5	45
bend solder dip 4.37 × φ 0.4		bend solder dip 4.37 × φ 0.5	46
		bend solder dip 6.35 × φ 0.5	47
		solder dip 4.37 × φ 0.4	51
		stackable straight to PCB 5.38 × φ 0.635	53
		stackable straight to PCB 6.2 × φ 0.635	54
		stackable straight to PCB 6.99 × φ 0.635	55

### Contact and termination type ( for 4 rows & 6 rows connectors)

pin (for plug)	code	socket (for receptacle)	code
solder cup (inner dia.): φ 0.7	17	solder dip 6.35 × φ 0.46	75*
SMT	19	solder cup (inner dia.): φ 0.7	76
bend solder dip 2.77 × φ 0.48	31	wire wrap 12.7 × □0.46	78*
bend solder dip 3.56 × φ 0.48	32	wire wrap 9.53 × □0.46	79*
bend solder dip 4.37 × φ 0.48	33	solder dip 2.77 × φ 0.46	81
solder dip 2.77 × φ 0.46	51	solder dip 3.56 × φ 0.46	82
solder dip 3.56 × φ 0.46	52	solder dip 4.37 × φ 0.46	83
solder dip 4.37 × φ 0.46	53	bend solder dip 2.77 × φ 0.48	84
		bend solder dip 3.56 × φ 0.48	85
		bend solder dip 3.56 × φ 0.48	85
		bend solder dip 4.37 × φ 0.48	86
*———only available on 4 rows connectors			

Note:All dimensions are in mm.

## R066-4 Series Electric Rectangular Connector(4 rows)

### R066-4 series plug, straight to PCB (with mounting ears)

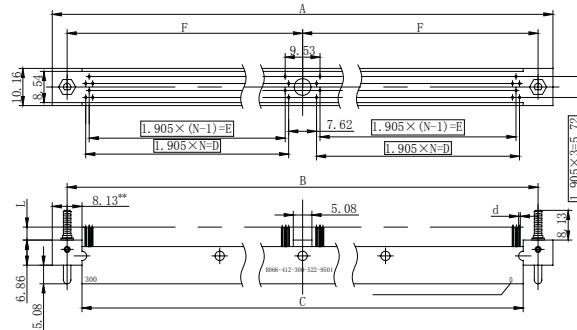

plug no.	A	B	C	D	E	F	N
R066-412-086-x x x-x x x x x	58.3	50.2	42	40	38.1	—	21
R066-412-110-x x x-x x x x x	69.7	61.6	53.5	51.4	49.5	—	27
R066-412-164-x x x-x x x x x	102.1	94	85.9	38.1	36.2	47	20
R066-412-196-x x x-x x x x x	117.4	109.2	101.1	45.7	43.8	54.6	24
R066-412-204-x x x-x x x x x	121.2	113	104.9	47.6	45.7	56.5	25
R066-412-220-x x x-x x x x x	128.8	120.7	112.5	51.4	49.5	60.3	27
R066-412-250-x x x-x x x x x	136.4	128.3	120.1	118.1	116.2	—	62
R066-412-276-x x x-x x x x x	155.5	147.3	139.2	64.8	62.9	73.7	34
R066-412-300-x x x-x x x x x	166.9	158.8	150.6	70.5	68.6	79.4	37
R066-412-404-x x x-x x x x x	216.4	208.3	200.2	95.3	93.4	104.1	50

\*-w/o mounting hole in the middle of connector

\*\*- only available for 86 pins connector, size is 7.11mm.

### Contact type

contact type	d	L
17	φ 0.7	2.5
51	φ 0.46	2.77
52	φ 0.46	3.56
53	φ 0.46	4.37

Note:All dimensions are in mm.



### R066-4 series plug, right angle to PCB (with mounting ears)

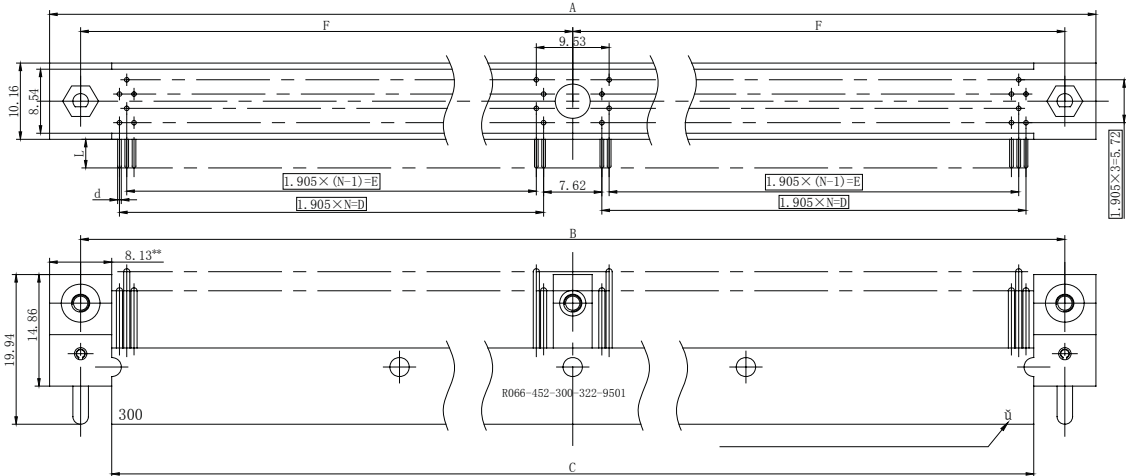

plug no.	A	B	C	D	E	F	N
R066-452-086-x x x-x x x x	58.3	50.2	42	40	38.1	—	21
R066-452-110-x x x-x x x x	69.7	61.6	53.5	51.4	49.5	—	27
R066-452-164-x x x-x x x x	102.1	94	85.9	38.1	36.2	47	20
R066-452-196-x x x-x x x x	117.4	109.2	101.1	45.7	43.8	54.6	24
R066-452-204-x x x-x x x x	121.2	113	104.9	47.6	45.7	56.5	25
R066-452-220-x x x-x x x x	128.8	120.7	112.5	51.4	49.5	60.3	27
R066-452-250-x x x-x x x x	136.4	128.3	120.1	118.1	116.2	—	62
R066-452-276-x x x-x x x x	155.5	147.3	139.2	64.8	62.9	73.7	34
R066-452-300-x x x-x x x x	166.9	158.8	150.6	70.5	68.6	79.4	37
R066-452-404-x x x-x x x x	216.4	208.3	200.2	95.3	93.4	104.1	50

\*- w/o mounting hole in the middle of connector \*\*- only available for 86 pins connector, size is 7.11mm.

### Contact type

	d	L
31	φ 0.48	2.77
32	φ 0.48	3.56
33	φ 0.48	4.37

Note: All dimensions are in mm.

## R066-4 series receptacle, straight to PCB (without mounting ears)

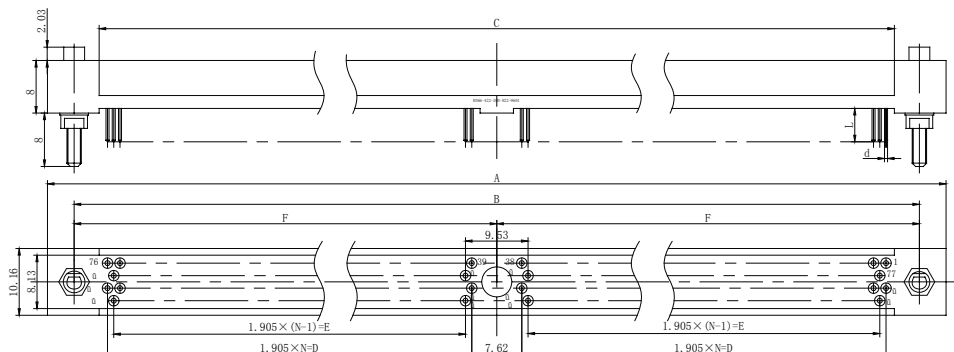

receptacle no.	A	B	C	D	E	F	N
R066-422-086-XXX-XXXX	58.3	50.2	42.5	40	38.1	—	21
R066-422-110-XXX-XXXX	69.7	61.6	54	51.4	49.5	—	27
	102.1	94	86.4	38.1	36.2	47	20
R066-422-196-XXX-XXXX	117.4	109.2	101.6	45.7	43.8	54.6	24
R066-422-204-XXX-XXXX	121.2	113	105.4	47.6	45.7	56.5	25
R066-422-220-XXX-XXXX	128.8	120.7	113	51.4	49.5	60.3	27
R066-422-250-XXX-XXXX	136.4	128.3	120.6	118.1	116.2	—	62
R066-462-276-XXX-XXXX	155.5	147.3	139.7	64.8	62.9	73.7	34
R066-422-300-XXX-XXXX	166.9	158.8	151.1	70.5	68.6	79.4	37
R066-422-404-XXX-XXXX	216.4	208.3	200.7	95.3	93.4	104.1	50

\*- w/o mounting hole in the middle of connector

### Contact type

contact type	d	L	Termination type
75	φ 0.46	6.35	solder dip
81	φ 0.46	2.77	
82	φ 0.46	3.56	
83	φ 0.46	4.37	
76	φ 0.7 (solder cup inner dia.)	2.5	solder cup
78	□0.46	12.7	wire wrap
79	□0.46	9.53	

Note: All dimensions are in mm.



**R066-4 series receptacle, right angle to PCB (with mounting ears)**

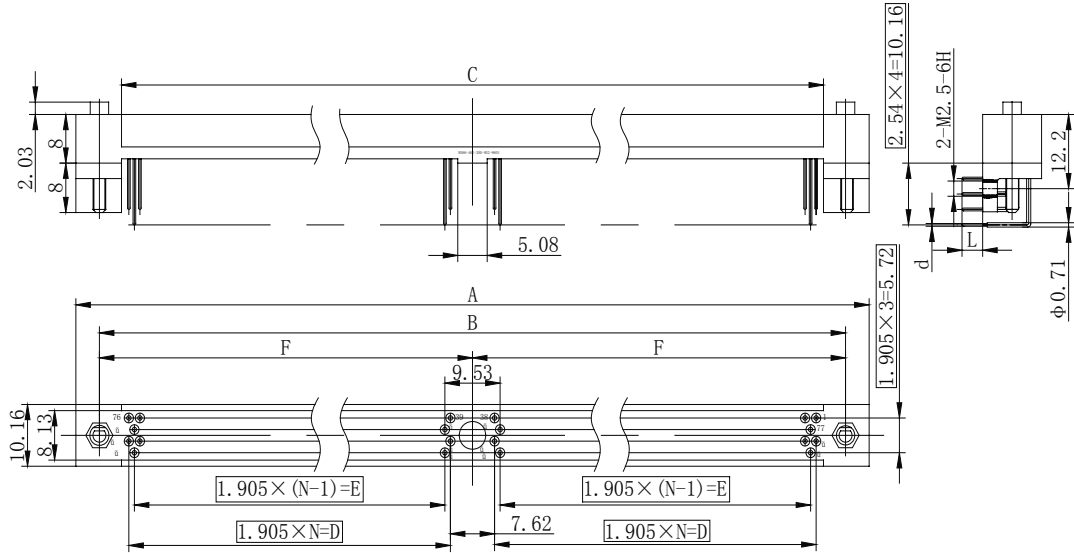

receptacle no.	A	B	C	D	E	F	N
R066-462-086-XXX-XXXX*	58.3	50.2	42.5	40	38.1	—	21
R066-462-110-XXX-XXXX*	69.7	61.6	54	51.4	49.5	—	27
R066-462-164-XXX-XXXX	102.1	94	86.4	38.1	36.2	47	20
R066-462-196-XXX-XXXX	117.4	109.2	101.6	45.7	43.8	54.6	24
R066-462-204-XXX-XXXX	121.2	113	105.4	47.6	45.7	56.5	25
R066-462-220-XXX-XXXX	128.8	120.7	113	51.4	49.5	60.3	27
R066-462-250-XXX-XXXX*	136.4	128.3	120.6	118.1	116.2	—	62
R066-462-276-XXX-XXXX	155.5	147.3	139.7	64.8	62.9	73.7	34
R066-462-300-XXX-XXXX	166.9	158.8	151.1	70.5	68.6	79.4	37
R066-462-404-XXX-XXXX	216.4	208.3	200.7	95.3	93.4	104.1	50

\*-w/o mounting hole in the middle of connector

**Contact type**

contact type	d	L
84	φ 0.48	2.77
85	φ 0.48	3.56
86	φ 0.48	4.37

# R066-4 Series Electric Rectangular Connector

## Product solid picture

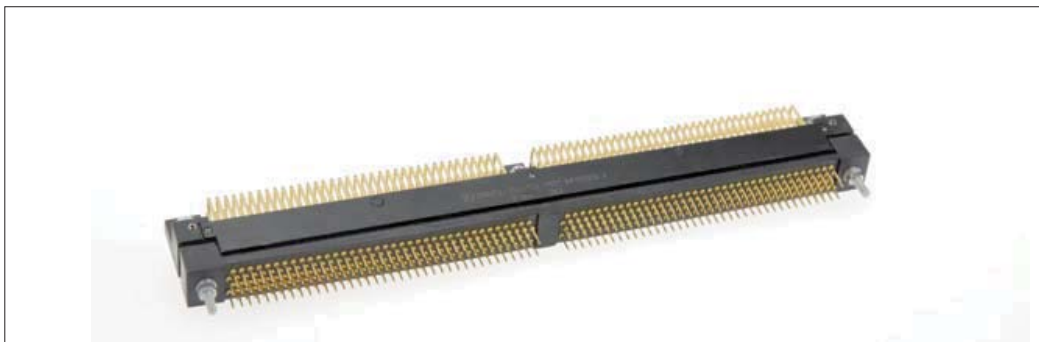

Contact no.	B	D	E	F	N		B	D	E	F	N
86 *	50.2	40	38.1	—	21	220	120.7	51.4	49.5	60.3	27
110 *	61.6	51.4	49.5	—	27	250 *	128.3	118.1	116.2	—	62
164	94	38.1	36.2	47	20	276	147.3	64.8	62.9	73.7	34
196	109.2	45.7	43.8	54.6	24	300	158.8	70.5	68.6	79.4	37
204	113	47.6	45.7	56.5	25	404	208.3	95.3	93.4	104.1	50

\*-w/o mounting hole in the middle of connector

## R066-4 plug appearance dimension

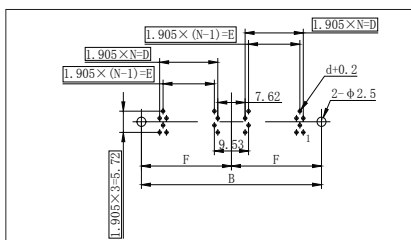

straight to PCB

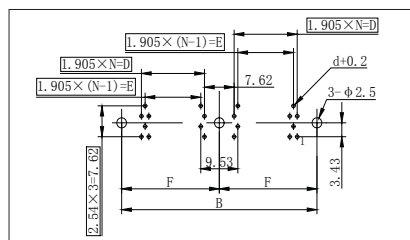

right angle to PCB

Contact no.	Contact arrangement	Contact no.	Contact arrangement
86*		220	
110*		250*	
164		276	
196		300	
204		403	

Note: All dimensions are in mm.



**R066-4 receptacle appearance dimension**

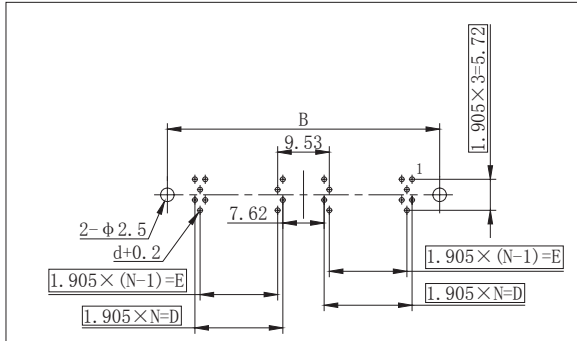

straight to PCB

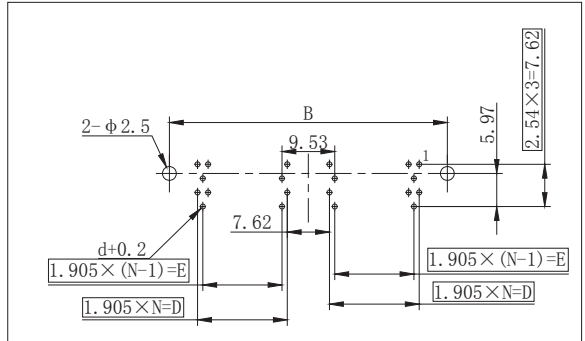

right angle to PCB

Contact no.	Contact arrangement	Contact no.	Contact arrangement
86*		220	
110*		250*	
164		276	
196		300	
204		404	

Note: All dimensions are in mm.



## R066-6 Series Electric Rectangular Connector(6 rows)

### R066-6 series plug, straight to PCB (with mounting ears)

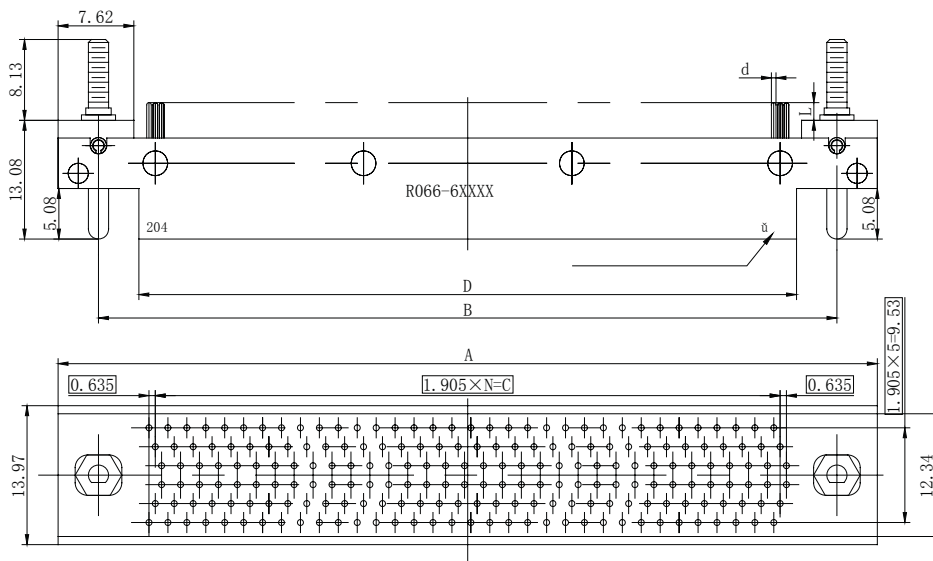

plug no.	A	B	C	D	E	N
R066-632-162-x x x-x x x x	69.1	61	50.8	52.8	53.3	26
R066-632-204-x x x-x x x x	82.4	74.3	64.3	66.2	66.7	33
R066-632-252-x x x-x x x x	97.7	89.5	79.4	81.4	81.9	41
R066-632-300-x x x-x x x x	112.9	104.8	94.6	96.6	97.16	49
R066-632-360-x x x-x x x x	132	123.8	113.7	115.6	116.2	59
R066-632-402-x x x-x x x x	145.3	137.2	127	129	129.5	66

### Contact type

contact type	d	L
17	φ 0.7	2.5
51	φ 0.46	2.77
52	φ 0.46	3.56
53	φ 0.46	4.37

Note: All dimensions are in mm.



## R066-6 series plug, right angle to PCB (with mounting ears)

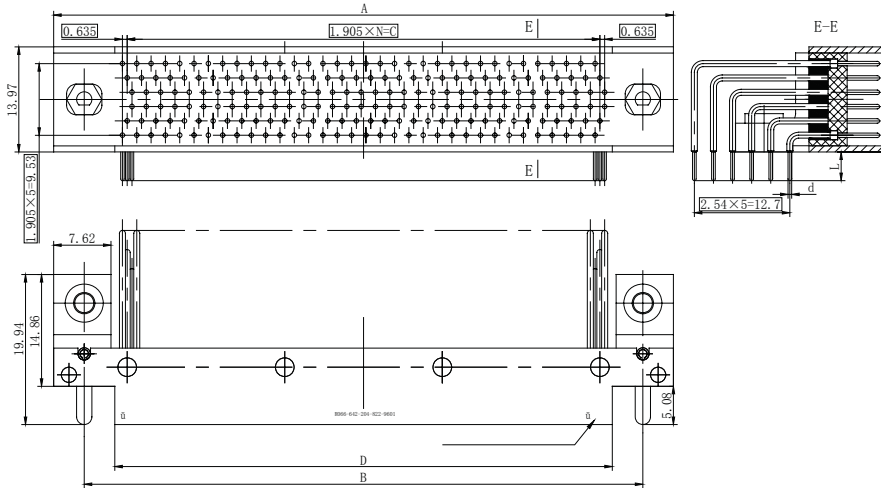

plug no.	A	B	C	D	E	N
R066-672-162-x x x-x x x x x	69.1	61	50.8	52.8	53.3	26
R066-672-204-x x x-x x x x x	82.4	74.3	64.3	66.2	66.7	33
R066-672-252-x x x-x x x x x	97.7	89.5	79.4	81.4	81.9	41
R066-672-300-x x x-x x x x x	112.9	104.8	94.6	96.6	97.16	49
R066-672-360-x x x-x x x x x	132	123.8	113.7	115.6	116.2	59
R066-672-402-x x x-x x x x x	145.3	137.2	127	129	129.5	66

### Contact type

contact type	d	L
31	φ 0.48	2.77
32	φ 0.48	3.56
33	φ 0.48	4.37

Note: All dimensions are in mm.

## R066-6 series receptacle, straight to PCB (without mounting ears)

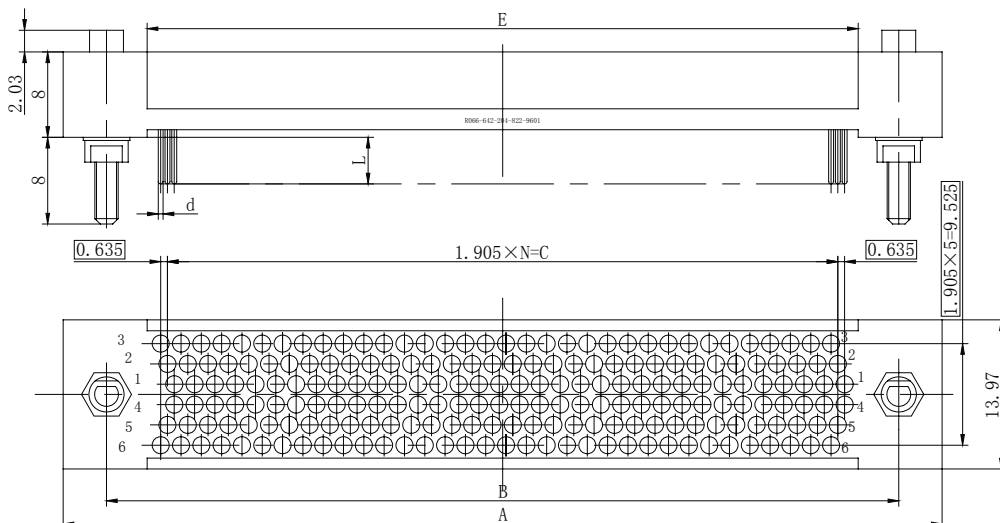

plug no.	A	B	C	D	E	N
R066-642-162-x x x - x x x x x	69.1	61	50.8	52.8	53.3	26
R066-642-204-x x x - x x x x x	82.4	74.3	64.3	66.2	66.7	33
R066-642-252-x x x - x x x x x	97.7	89.5	79.4	81.4	81.9	41
R066-642-300-x x x - x x x x x	112.9	104.8	94.6	96.6	97.16	49
R066-642-360-x x x - x x x x x	132	123.8	113.7	115.6	116.2	59
R066-642-402-x x x - x x x x x	145.3	137.2	127	129	129.5	66

### Contact type

contact type	d	L	termination type
76	φ 0.7	2.5	solder cup
81	φ 0.46	2.77	solder dip
82	φ 0.46	3.56	
83	φ 0.46	4.37	

Note: All dimensions are in mm.



## R066-6 series receptacle, right angle to PCB (with mounting bracket)

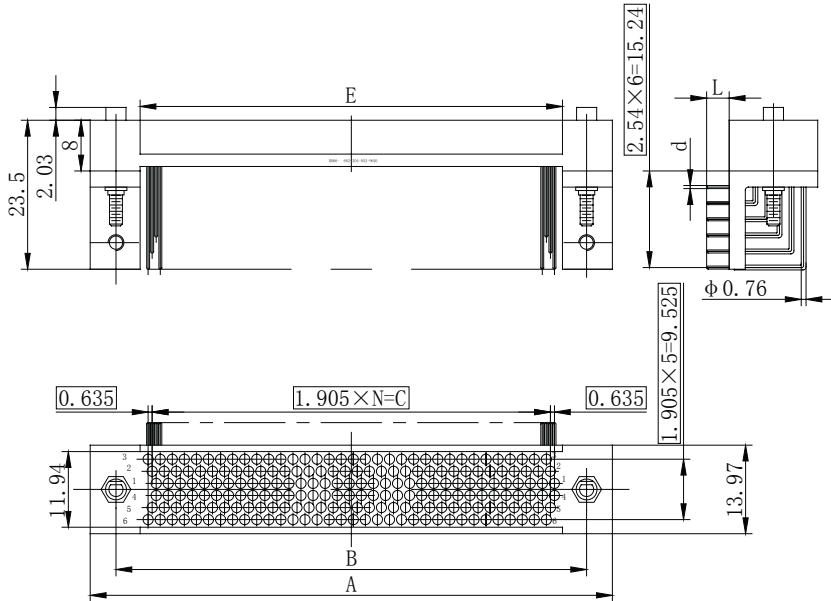

plug no.	A	B	C	D	E	N
R066-682-162-x x x -x x x x	69.1	61	50.8	52.8	53.3	26
R066-682-204-x x x -x x x x	82.4	74.3	64.3	66.2	66.7	33
R066-682-252-x x x -x x x x	97.7	89.5	79.4	81.4	81.9	41
R066-682-300-x x x -x x x x	112.9	104.8	94.6	96.6	97.16	49
R066-682-360-x x x -x x x x	132	123.8	113.7	115.6	116.2	59
R066-682-402-x x x -x x x x	145.3	137.2	127	129	129.5	66

### Contact type

contact type	d	L
84	φ 0.48	2.77
85	φ 0.48	3.56
86	φ 0.48	4.37

Note: All dimensions are in mm.

## R066-6 Series Electric Rectangular Connector

### Product solid picture

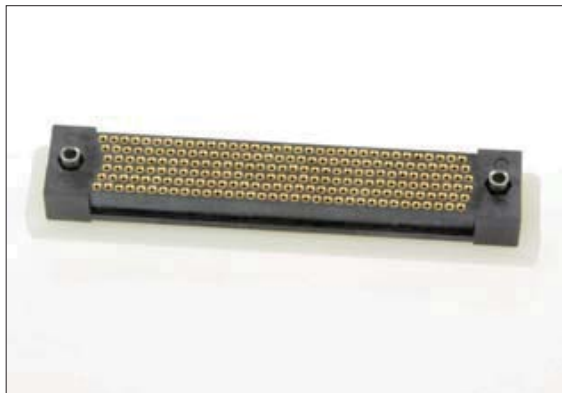

### R066-6 plug appearance dimension

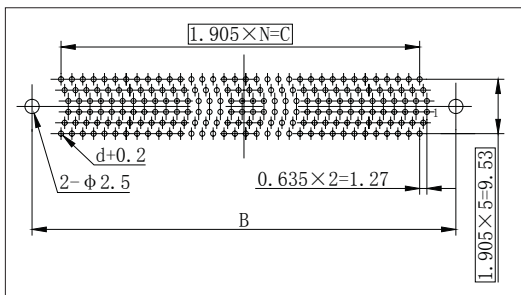

straight to PCB

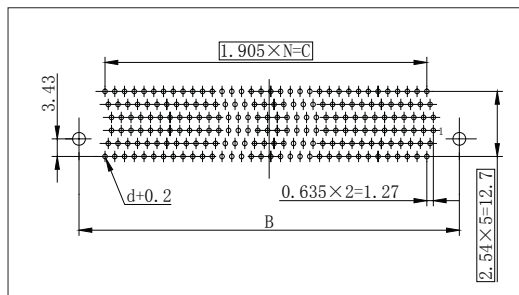

right angle to PCB

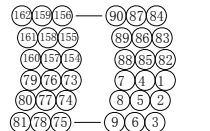
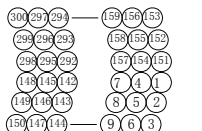
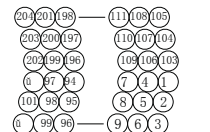
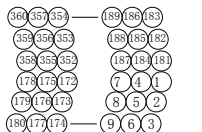
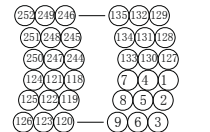
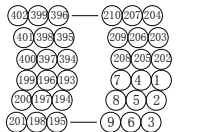
Contact no.	Contact arrangement	Contact no.	Contact arrangement
162		300	
204		360	
252		402	

Note: All dimensions are in mm.



### R066-6 receptacle appearance dimension

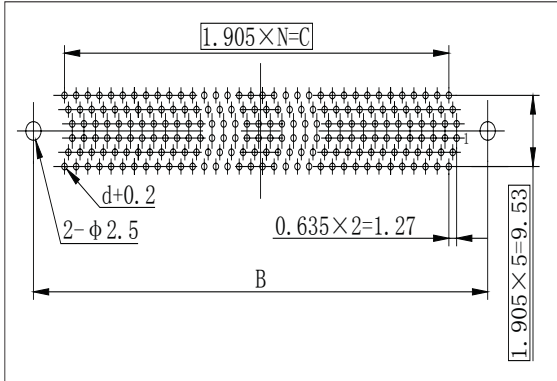

straight to PCB

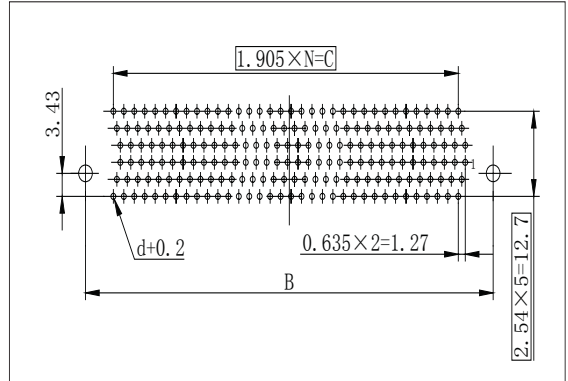

right angle to PCB

Contact no.	Contact arrangement	Contact no.	Contact arrangement
162	162 159 156 — 90 87 84 161 158 155 — 89 86 83 160 157 154 — 88 85 82 79 76 73 — 7 4 1 80 77 74 — 8 5 2 81 78 75 — 9 6 3	300	300 297 294 — 158 156 153 299 296 293 — 158 155 152 298 295 292 — 157 154 151 148 145 142 — 7 4 1 149 146 143 — 8 5 2 150 147 144 — 9 6 3
204	204 201 198 — 111 108 105 203 200 197 — 110 107 104 202 199 196 — 109 106 103 97 94 — 7 4 1 101 98 95 — 8 5 2 99 96 — 9 6 3	360	360 357 354 — 189 186 183 359 356 353 — 188 185 182 358 355 352 — 187 184 181 178 175 172 — 7 4 1 179 176 173 — 8 5 2 180 177 174 — 9 6 3
252	252 249 246 — 135 132 129 251 248 243 — 134 131 128 250 247 244 — 133 130 127 124 121 118 — 7 4 1 125 122 119 — 8 5 2 126 123 120 — 9 6 3	402	402 399 396 — 210 207 204 401 398 395 — 209 206 203 400 397 394 — 208 205 202 199 196 193 — 7 4 1 200 197 194 — 8 5 2 201 198 195 — 9 6 3

Note: All dimensions are in mm.